

yimumu

design & consulting

yimumu design & consulting

创意设计中心
Seidenberggässchen 61
CH-3074 Muri bei Bern
yi.salomo@gmx.ch
T +41 79 827 63 89

市场运营中心
Shanghai, China
Chongqing, China
T +86 13527361567

Bern, 17 .09.2019

翌森

ZYBIO MEDICAL

RENDERINGS



ZYBIO MEDICAL

INSTRUCTIONS FOR MATERIALS



ZYBIO MEDICAL

材料说明

直径40mm圆管支架

吸塑发光字侧面白色
正面蓝色发光, 侧面、背面
不发光(背面贴蓝色车贴)

水滴材质为密度板, 先雕刻形状,
再泡水塑形, 晾干后再喷漆

背景墙黑色哑光烤漆

木结构贴写真画面
蓝色小点不干胶雕刻

异形背板白色哑光烤漆

亚克力板(底部三角支撑)

仪器台白色哑光烤漆

仪器台白色哑光烤漆

吸塑发光字侧面白色
正面蓝色发光, 侧面、背面
不发光(背面贴蓝色车贴)

LED灯带 光线均匀

地台黑色、白色拼接(地胶、淋油板)

200

4000

700

750

1100

550

850



100

1G18

不干胶刻字
吸塑发光字侧面白色
正面蓝色发光, 侧面、背面
不发光(背面贴蓝色车贴)

70寸 电视

不干胶刻字

不干胶刻字

凹槽顶部发光灯带(光线均匀)

凹槽顶部发光灯带(光线均匀)

LED灯带 光线均匀

单位:毫米

ZYBIO MEDICAL

RENDERINGS

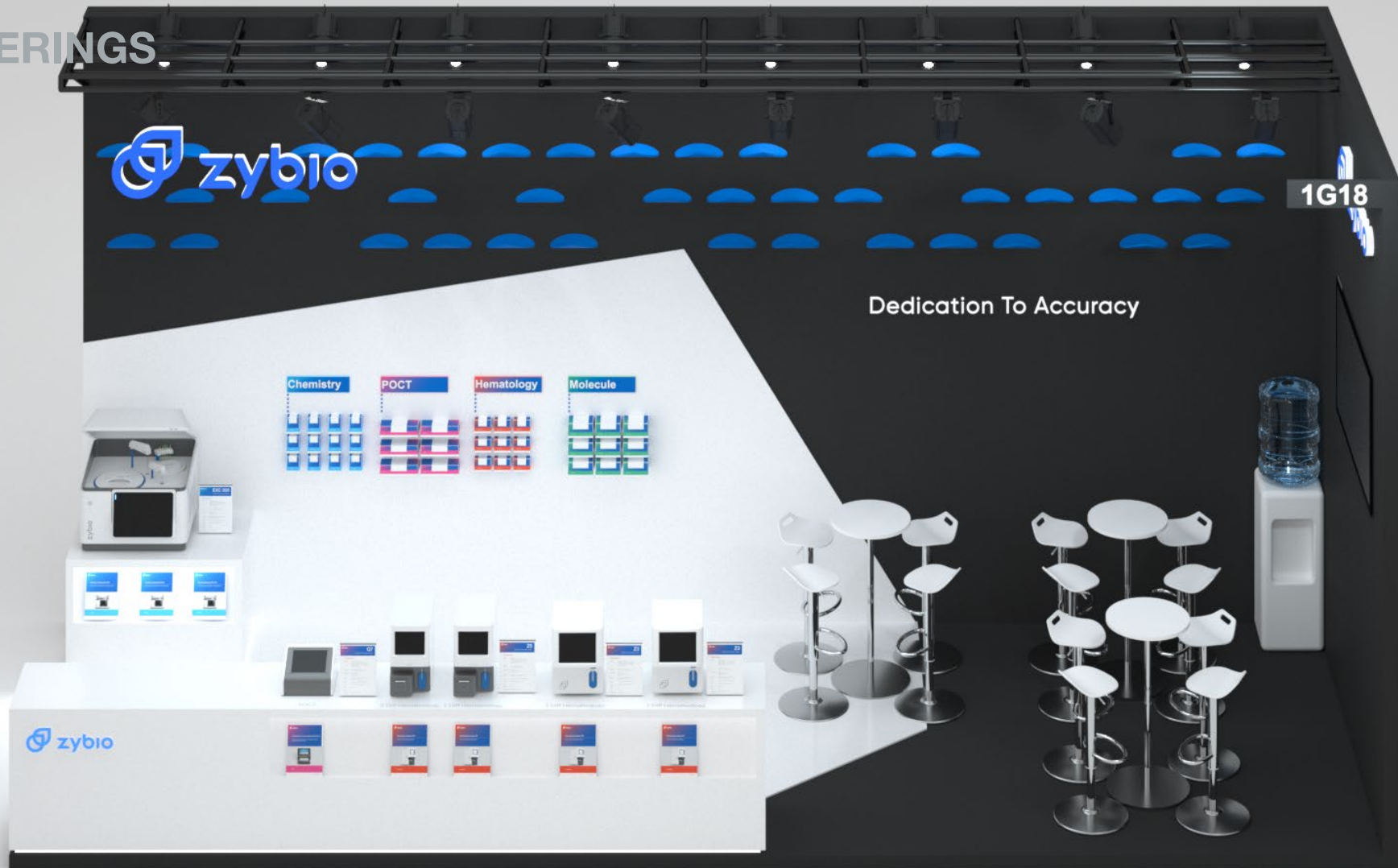

ZYBIO MEDICAL

RENDERINGS



ZYBIO MEDICAL

RENDERINGS



ZYBIO MEDICAL

FRONT VIEW

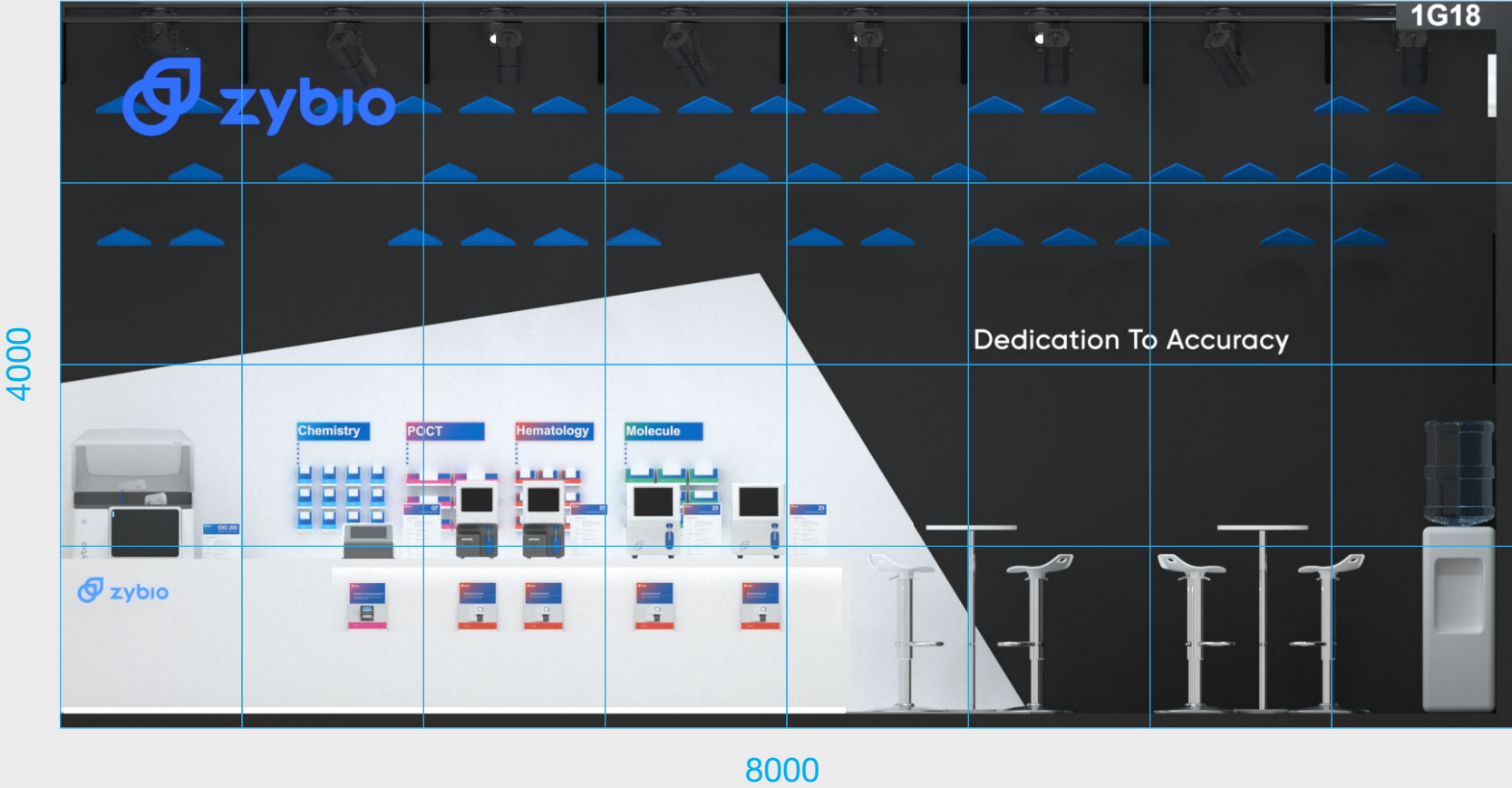

ZYBIO MEDICAL

TOP VIEW

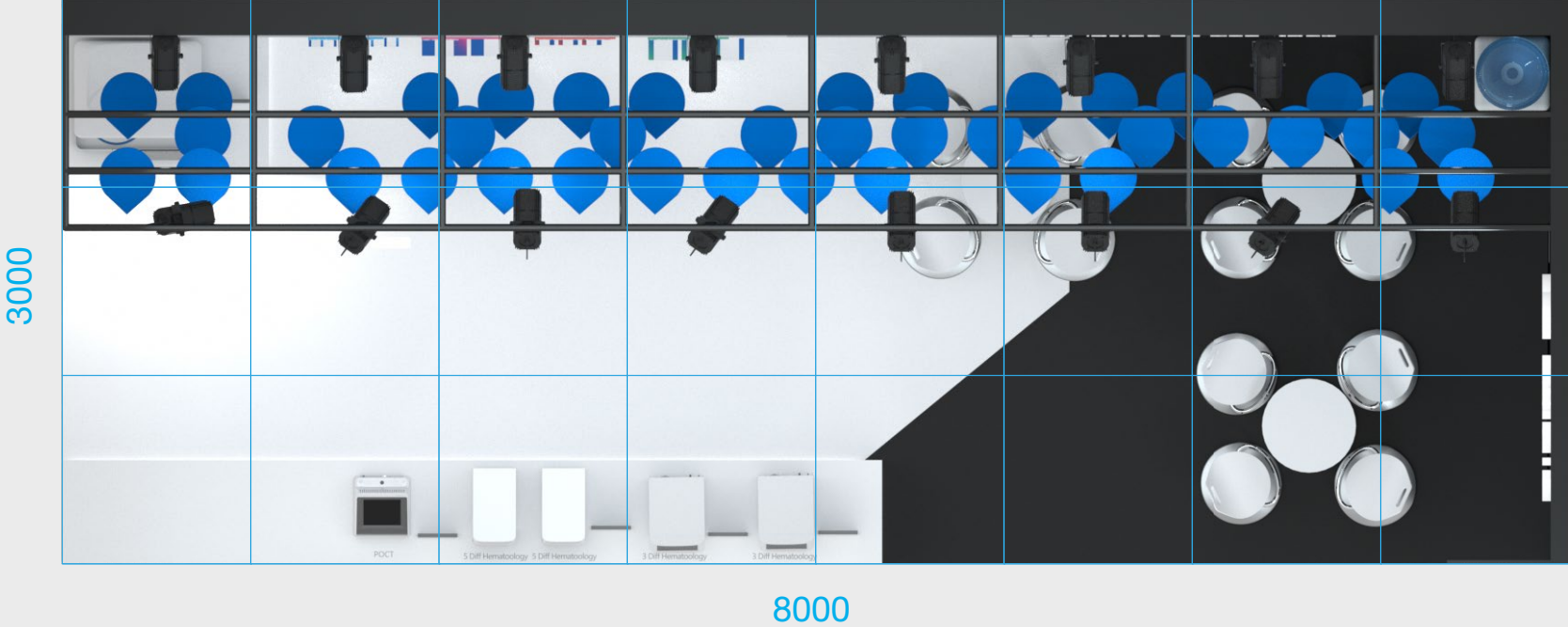

ZYBIO MEDICAL

LEFT VIEW

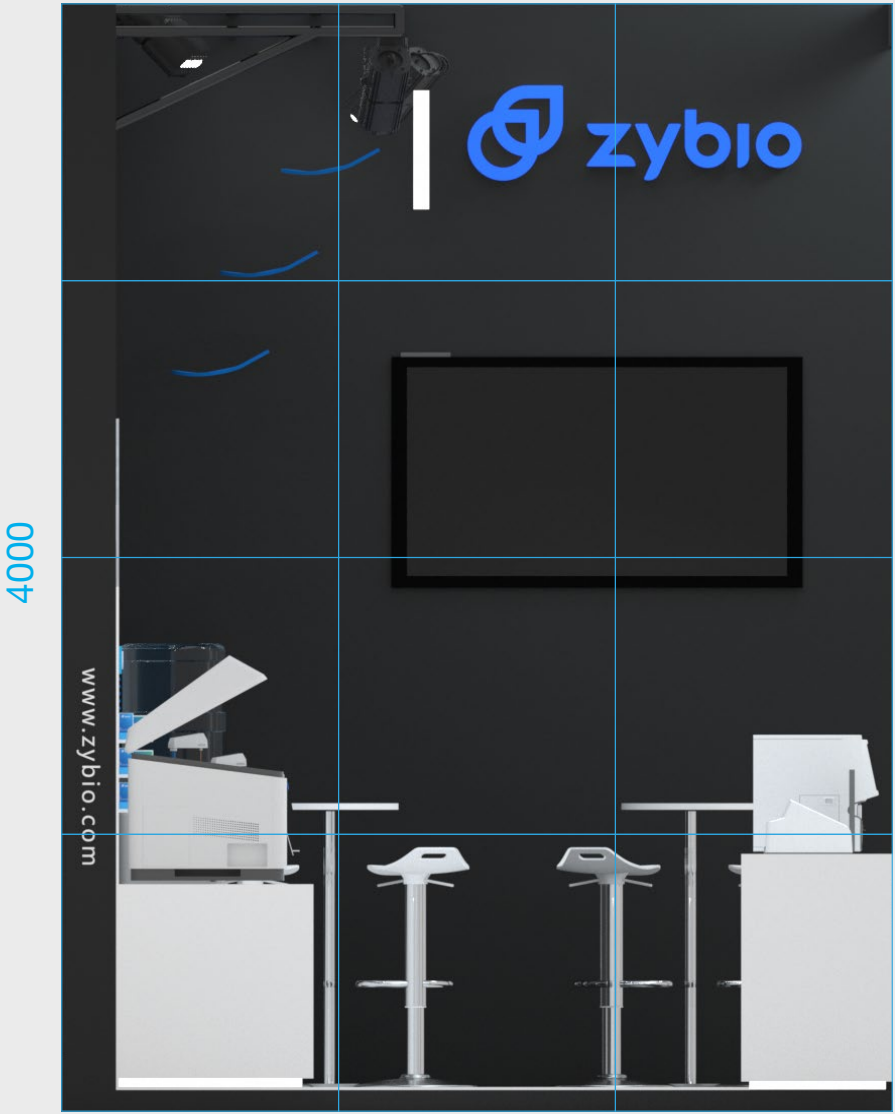

ZYBIO MEDICAL

BACKWALL SIZE

白色异形背板, 白色哑光烤漆, 厚度40mm. 背后装有发光灯带.

木结构贴写真画面, 厚度为10mm.

亚克力盒子, 厚度5mm, 深度140mm. 尺寸如下

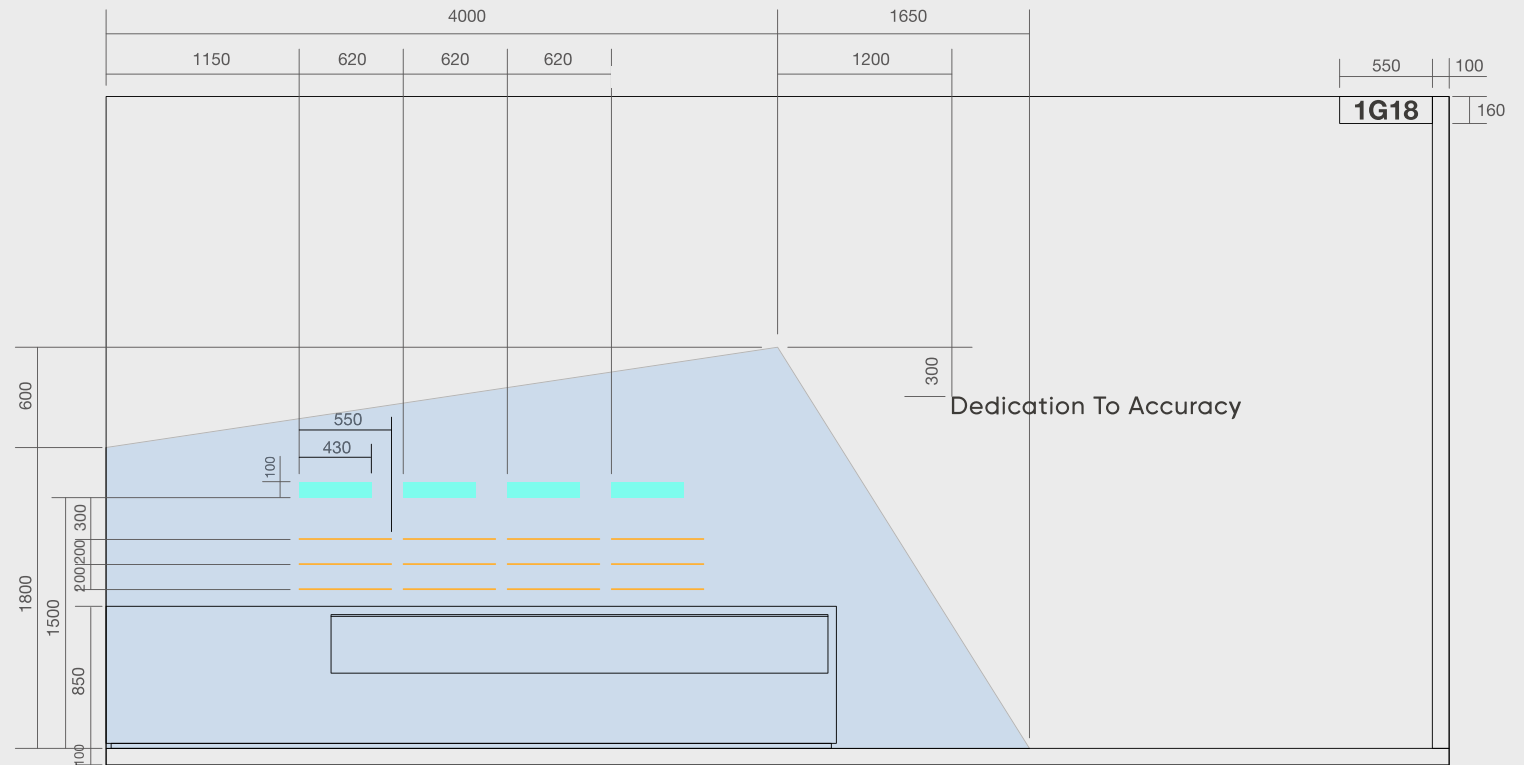
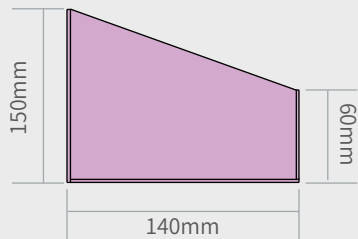

ZYBIO MEDICAL

GROUND SIZE

 White carpet

 Black carpet

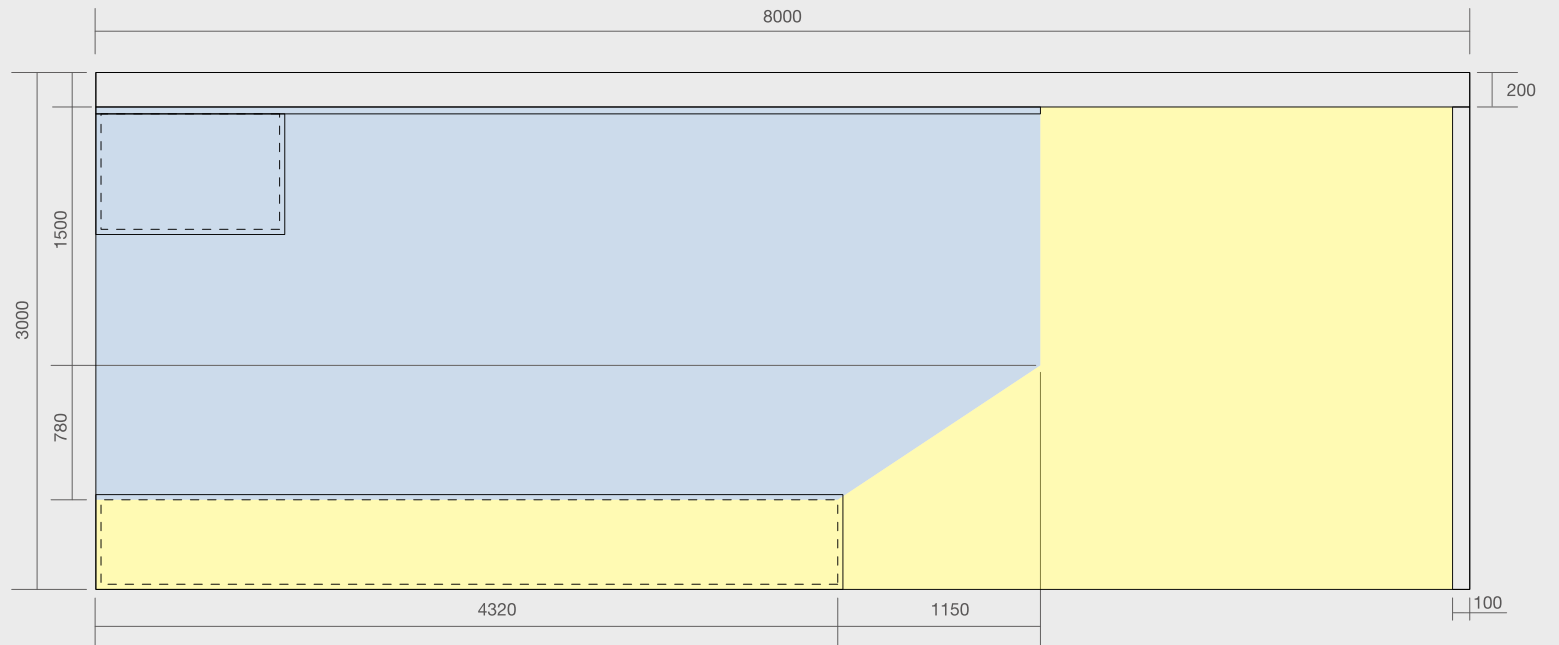

ZYBIO MEDICAL

地面尺寸

70寸液晶电视, 内嵌式固定在墙上. 尺寸根据实际电视尺寸定. (四周需留出操作空间)

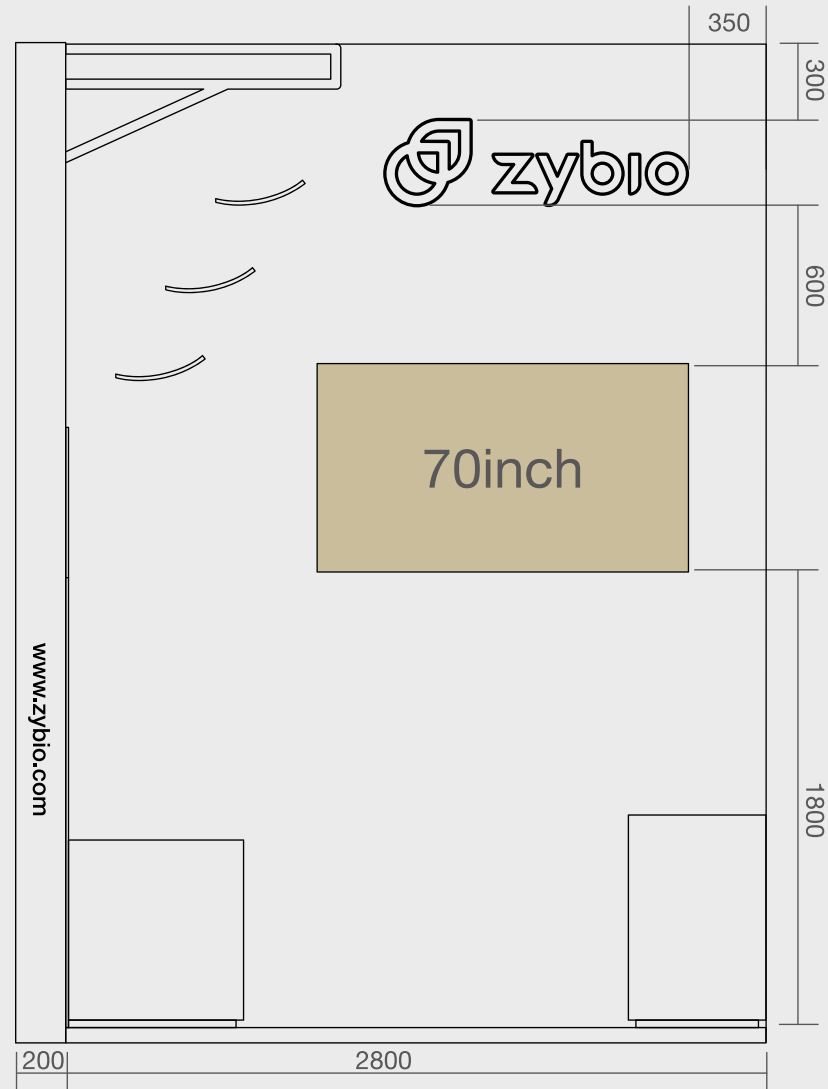

ZYBIO MEDICAL

前台仪器柜尺寸

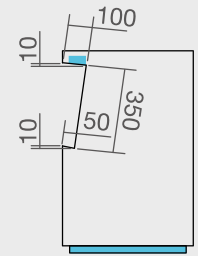
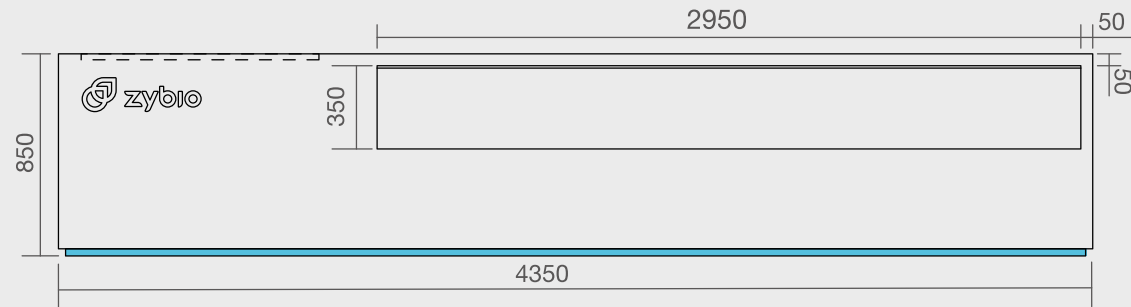

发光灯带, 光线均匀, 不要让灯珠反射

此处为长1000mm宽25mm 深度25mm的名片凹槽, 内部需打磨光滑

此处为仪器通线孔, 需安装直径60mm的线孔盖. (盖子的颜色与桌面一致)

柜门四周间隙为20mm

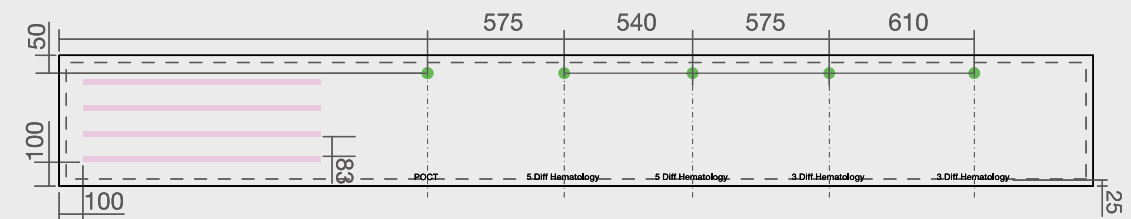
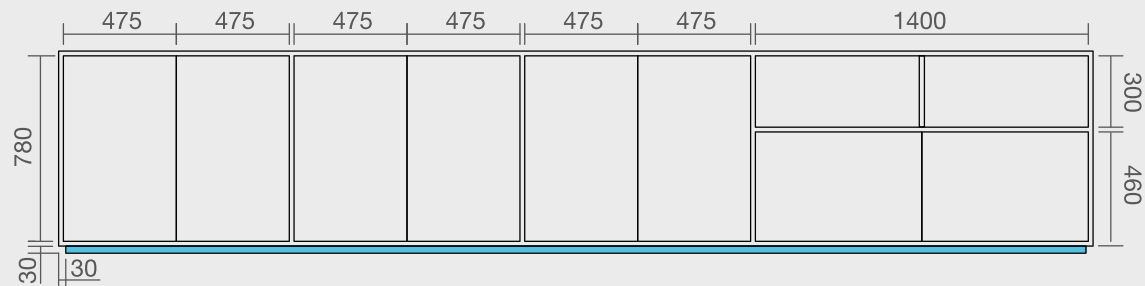

ZYBIO MEDICAL

背墙仪器柜尺寸



发光灯带, 光线均匀, 不要让灯珠反射



此处为仪器通线孔, 需安装直径60mm的线孔盖. (盖子的颜色与桌面一致)

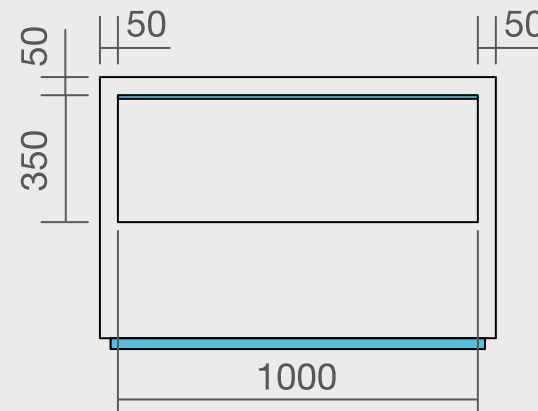

正视图

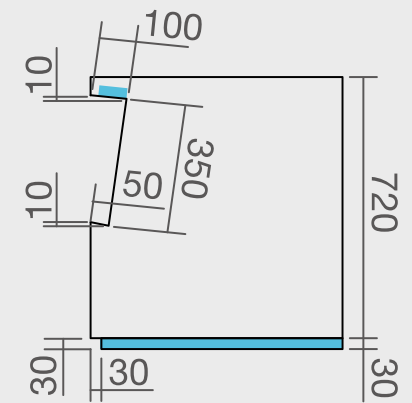

剖面图

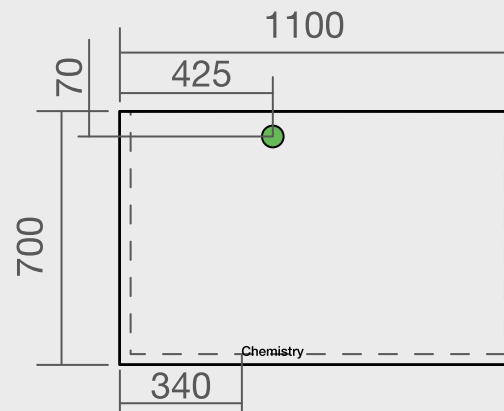

顶视图

ZYBIO MEDICAL

水滴尺寸

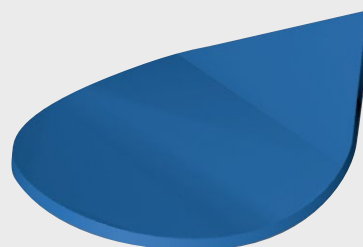
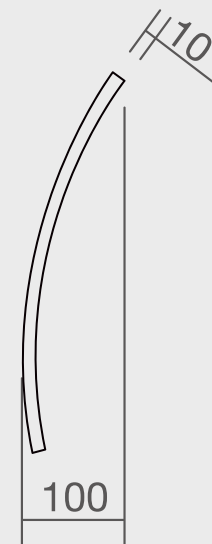
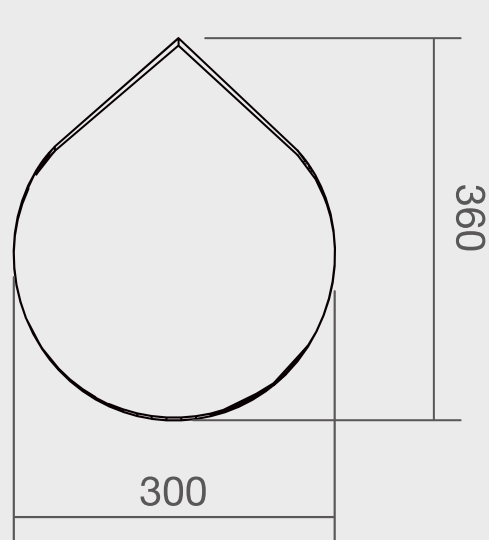

ZYBIO MEDICAL

水滴安装图

共40个

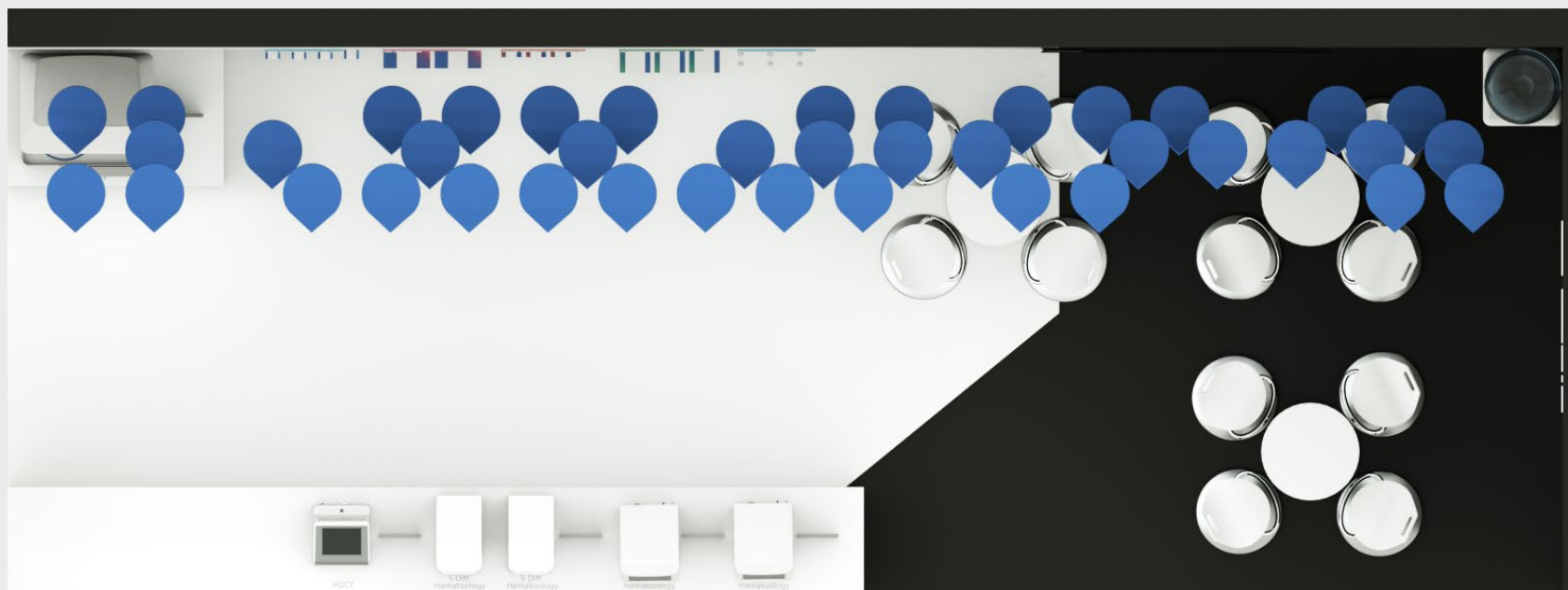

ZYBIO MEDICAL

水滴安装图

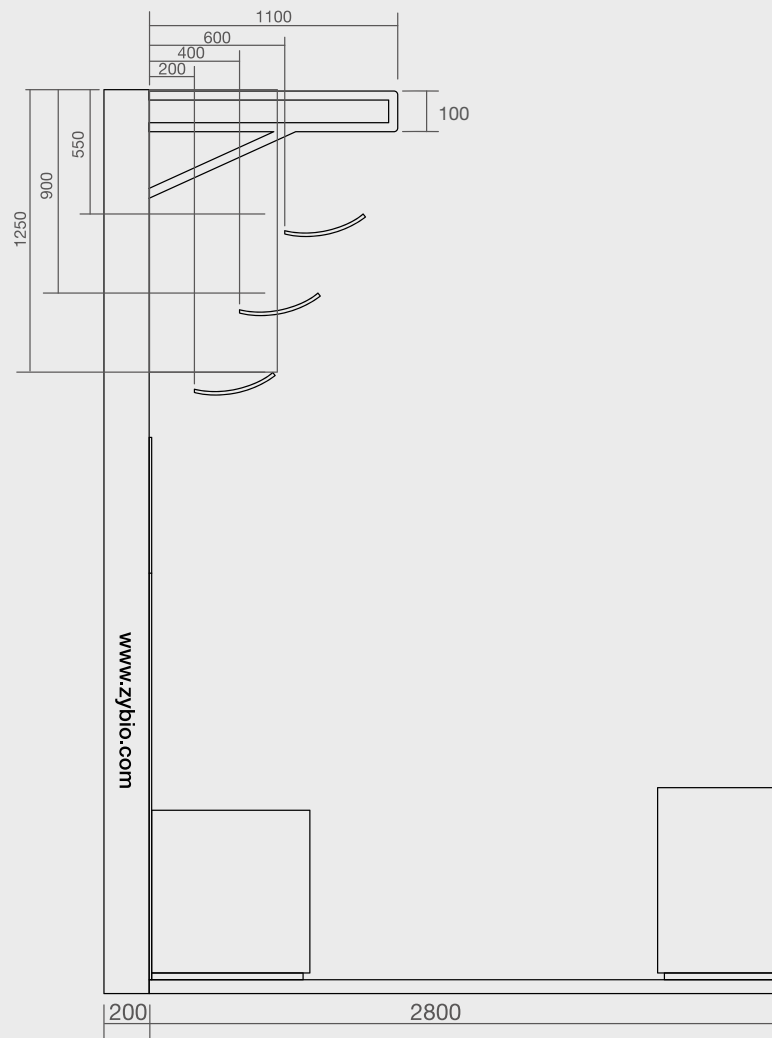

ZYBIO MEDICAL

水滴安装图 第一层14个

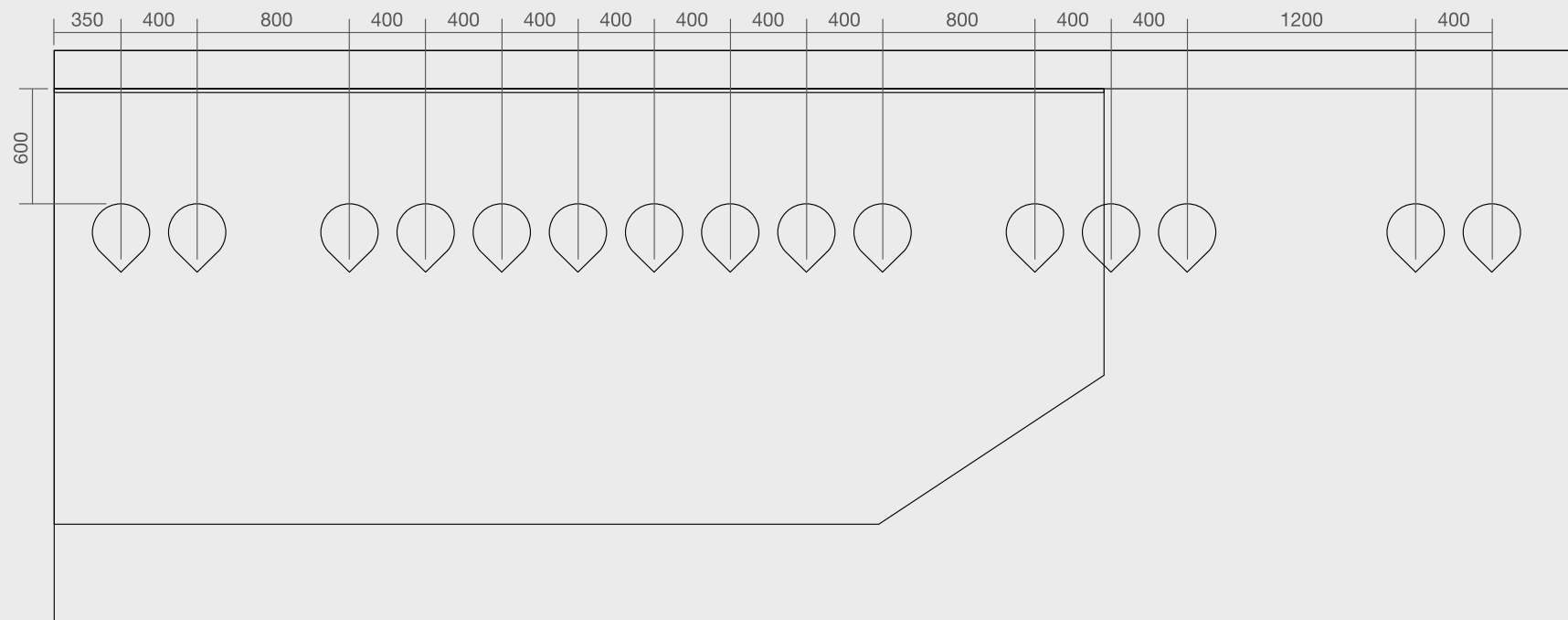

ZYBIO MEDICAL

水滴安装图 第二层13个

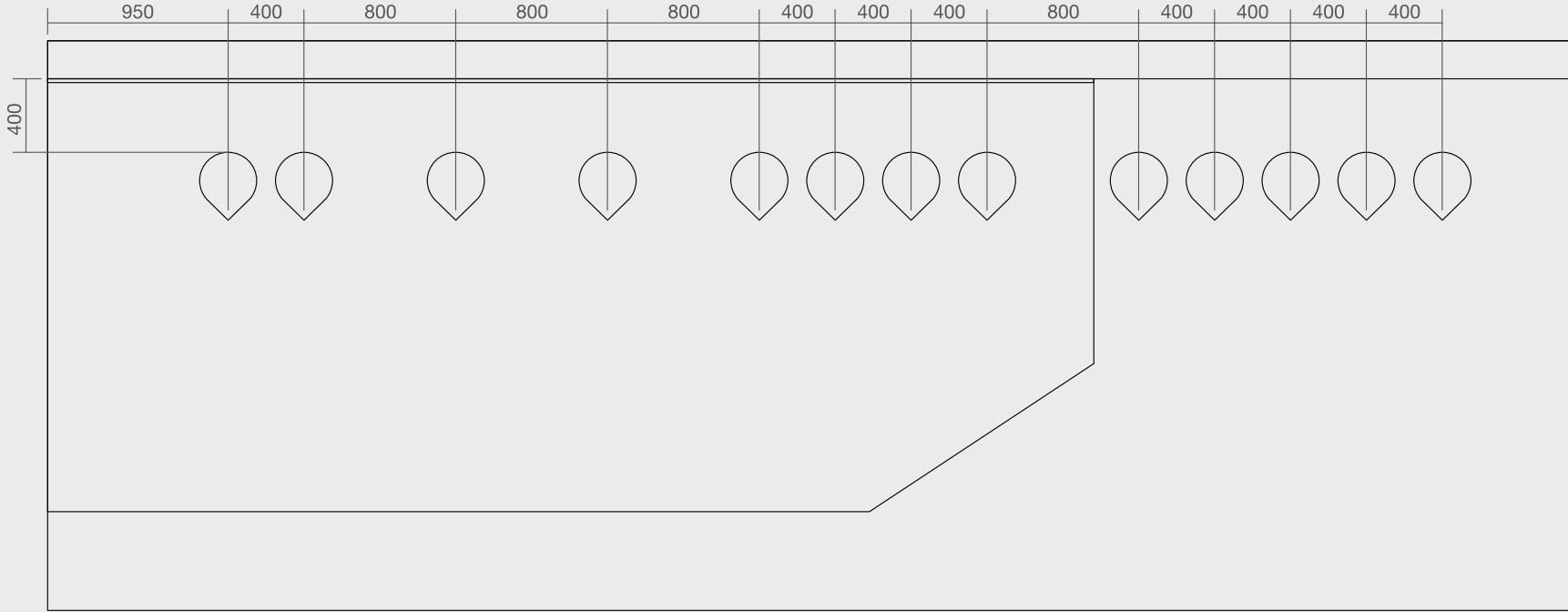

ZYBIO MEDICAL

水滴安装图 第三层14个

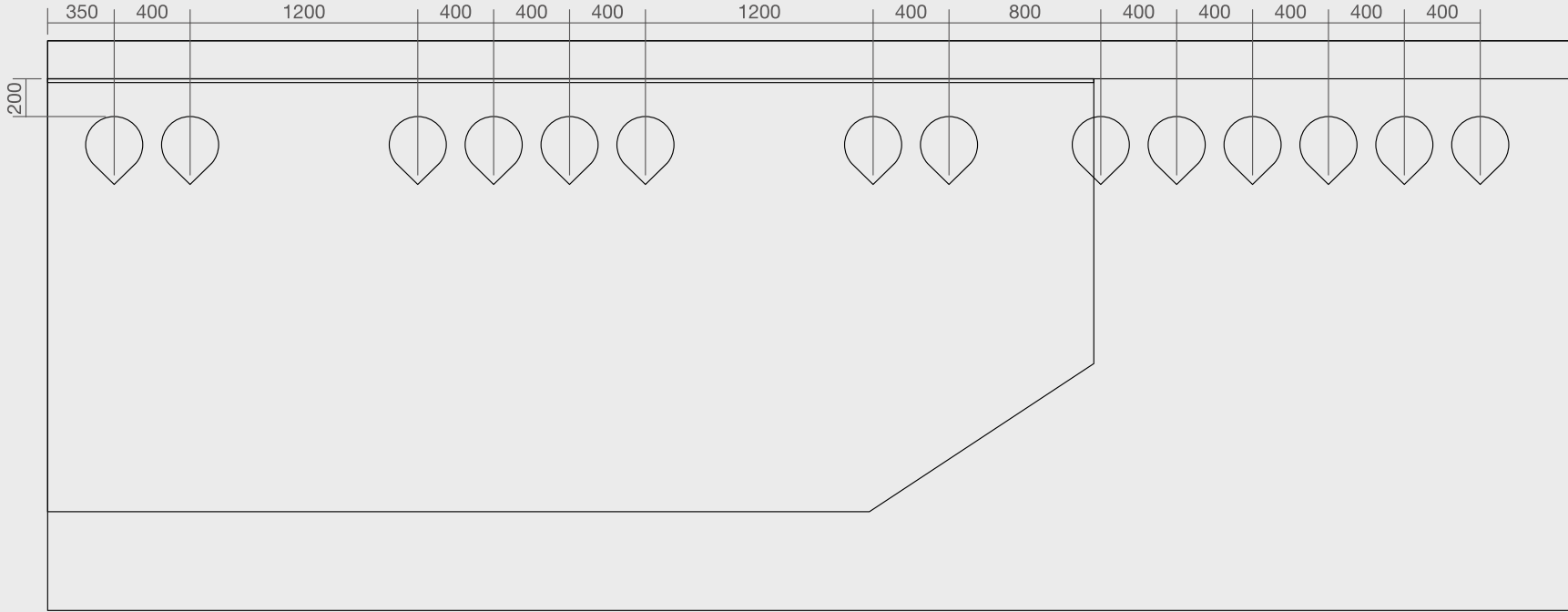

ZYBIO MEDICAL

平面文件安装位置

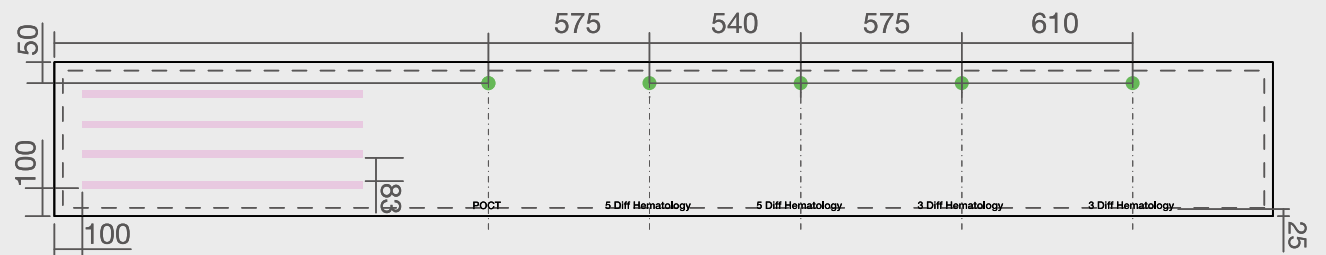
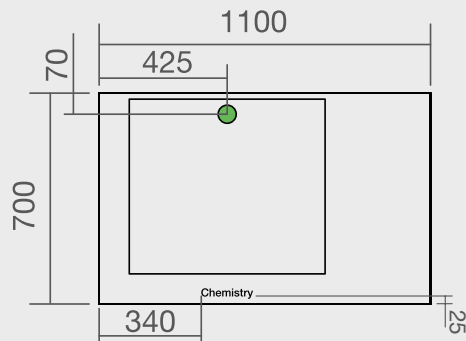
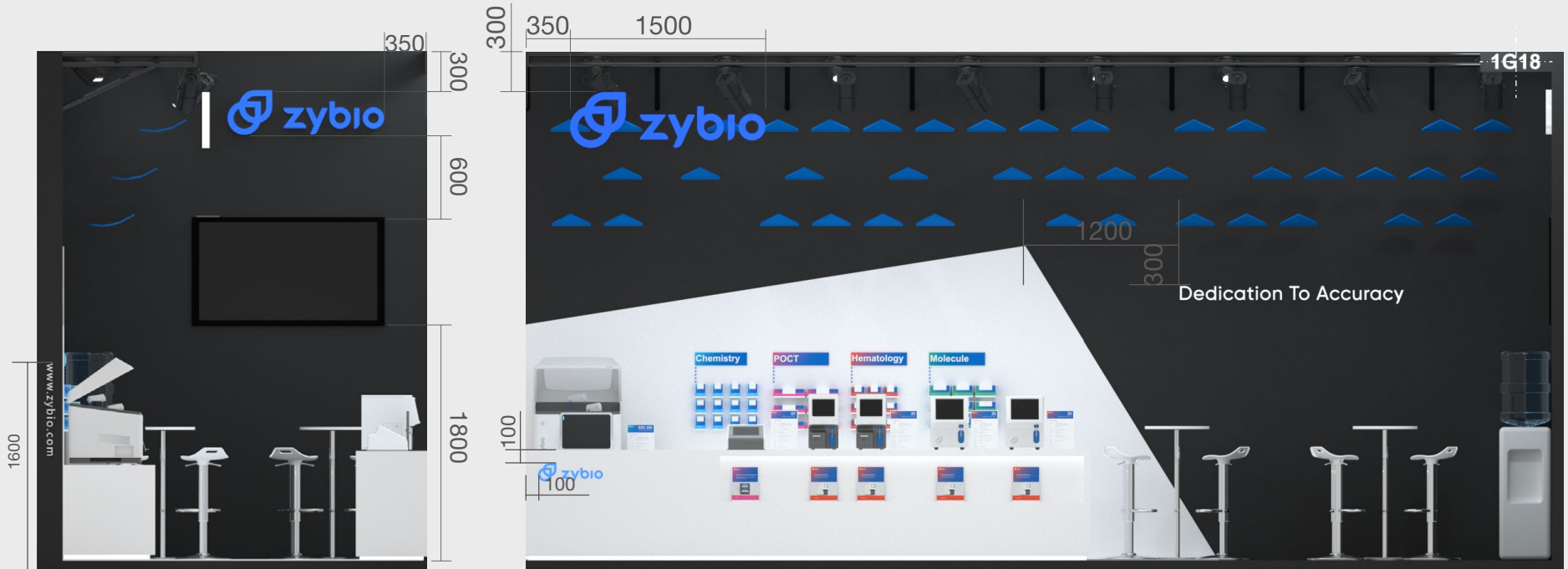

谢谢!
Danke!