

Layout

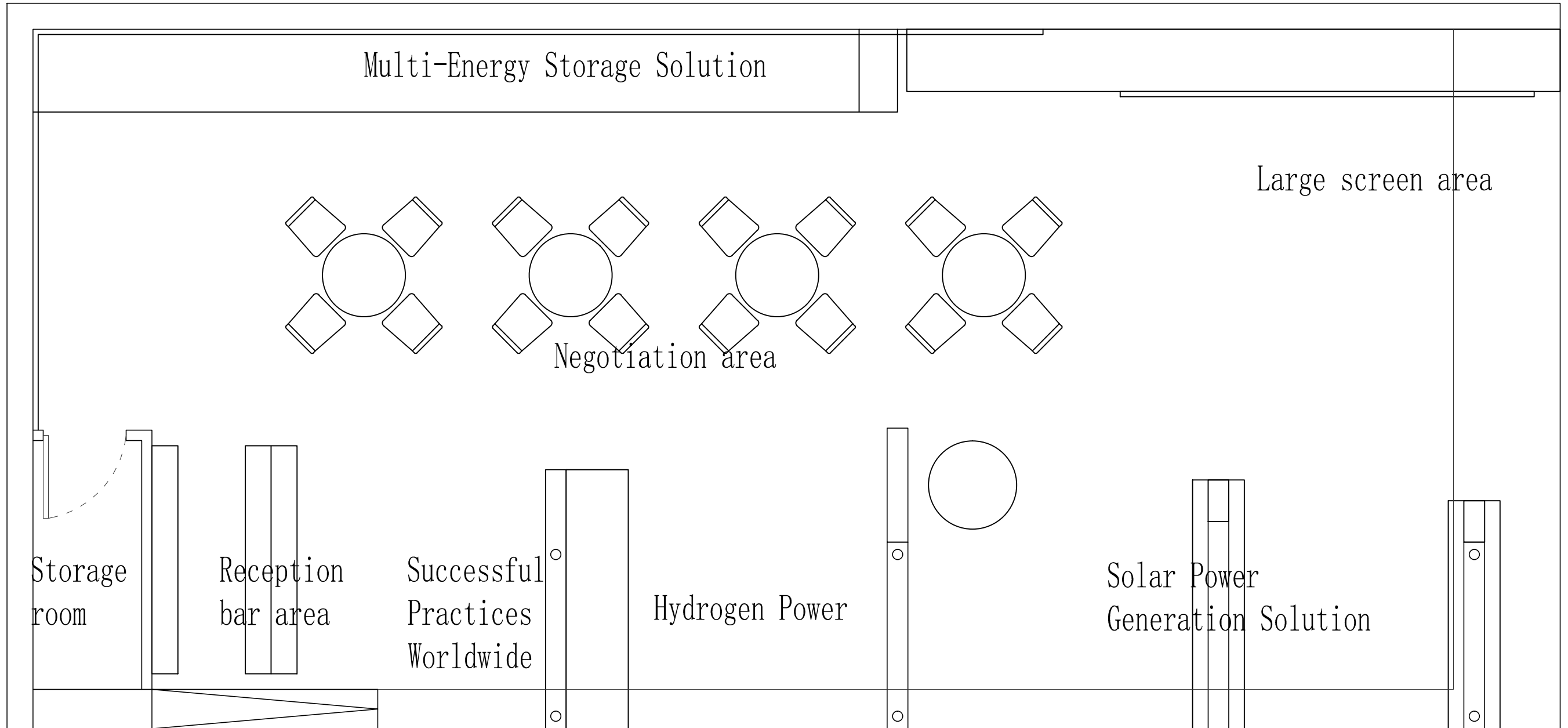

Ceiling positioning diagram

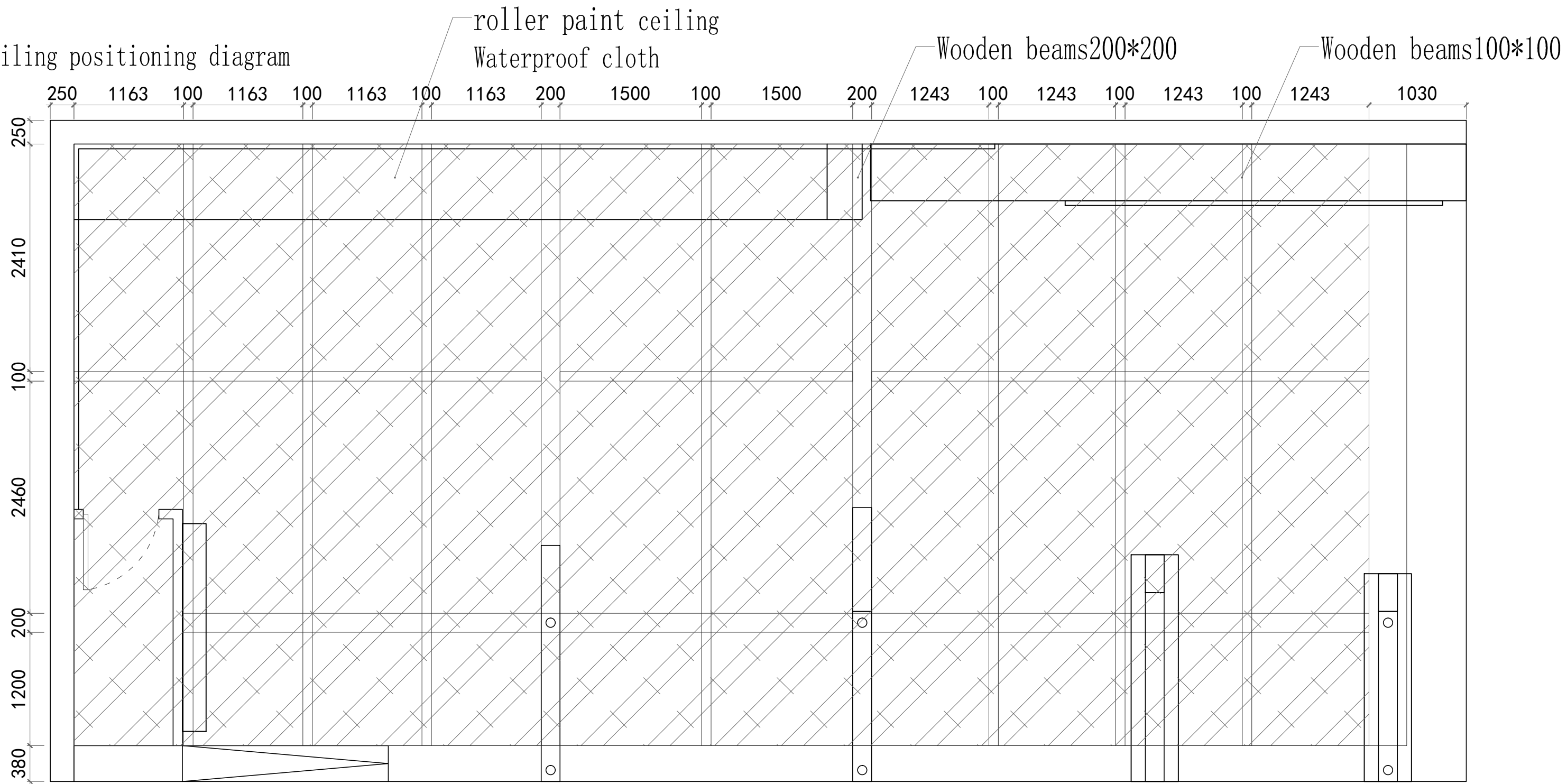

roller paint ceiling+Wooden beams+Waterproof cloth

Facade Index

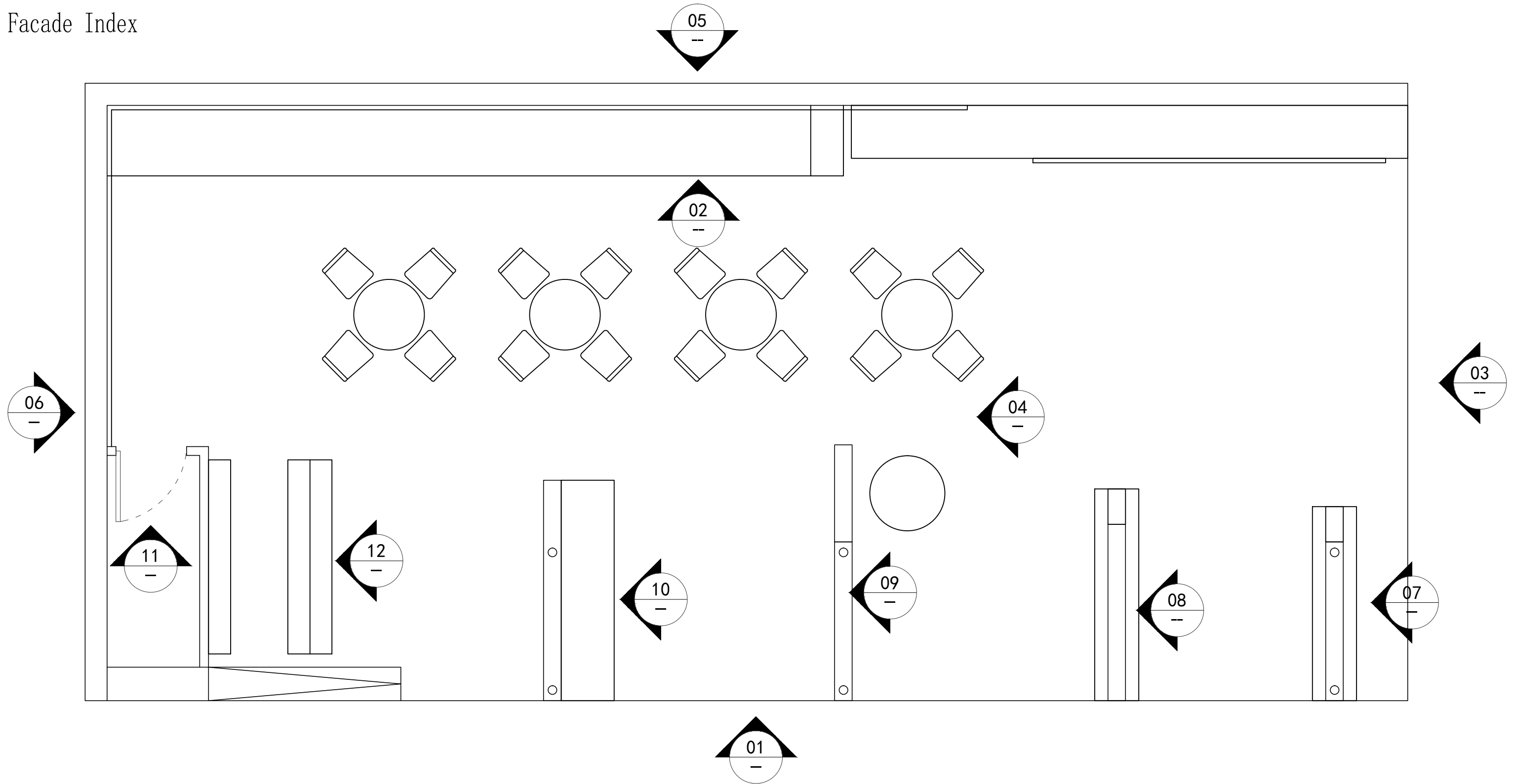

Socket layout diagram

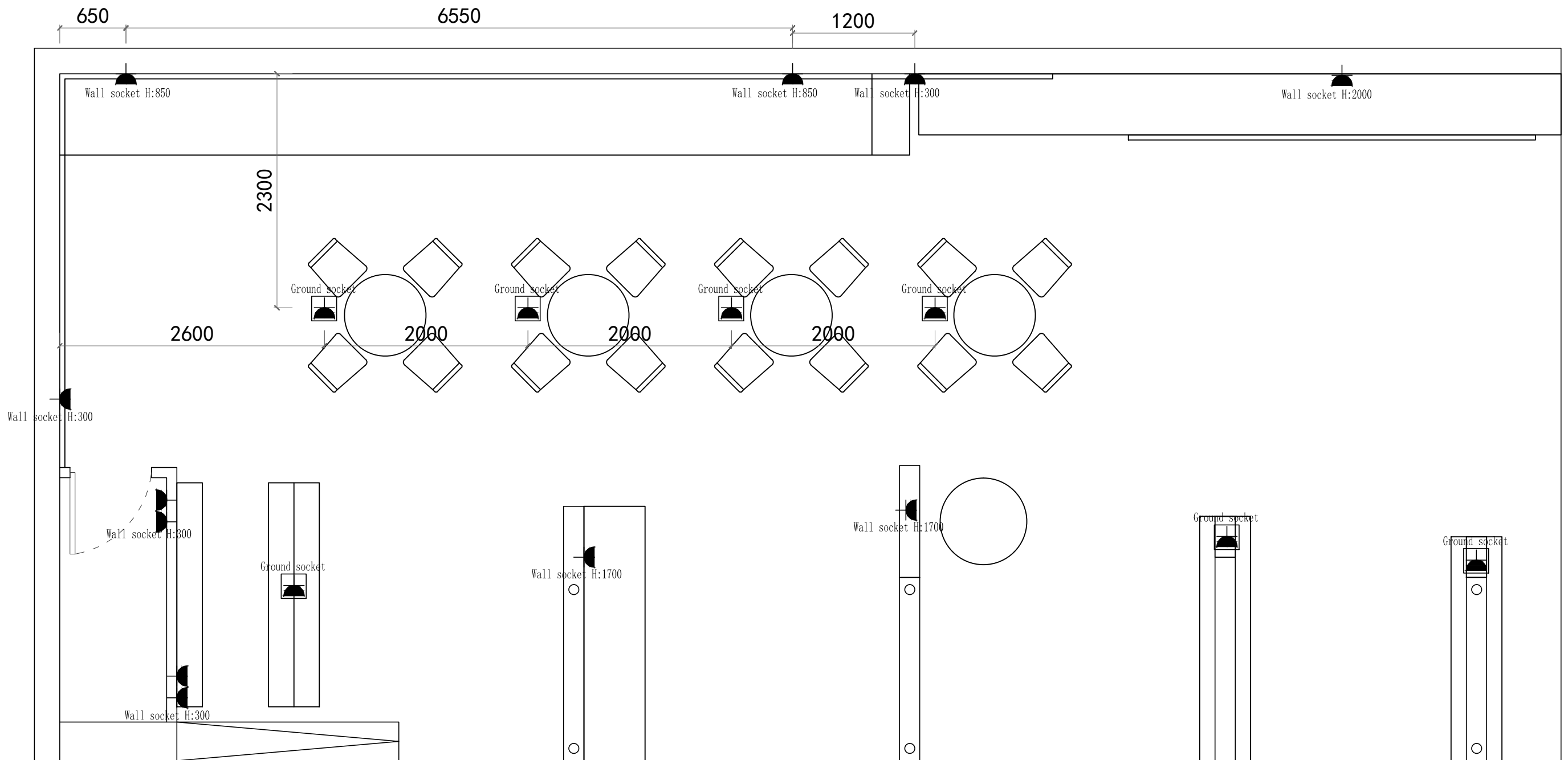

Lighting arrangement diagram

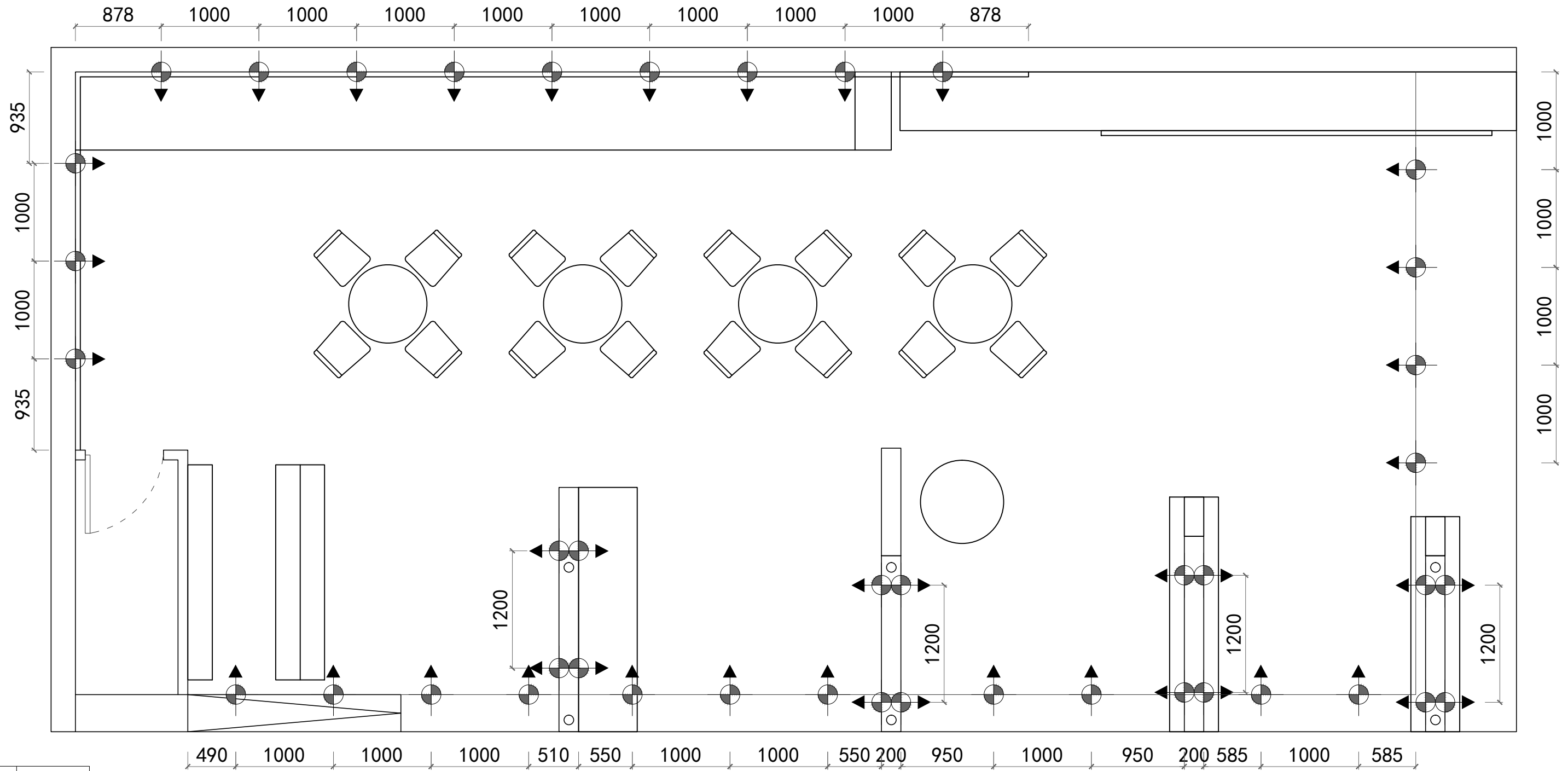

Elevation 01

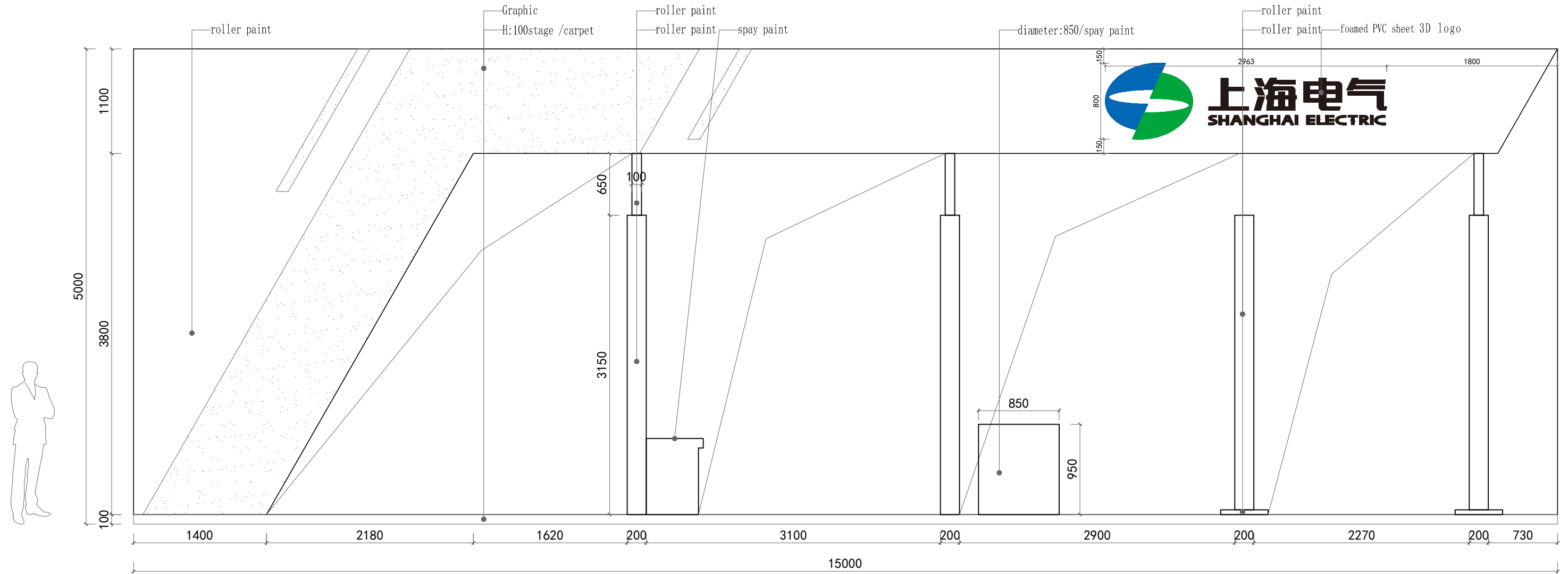

Elevation 02

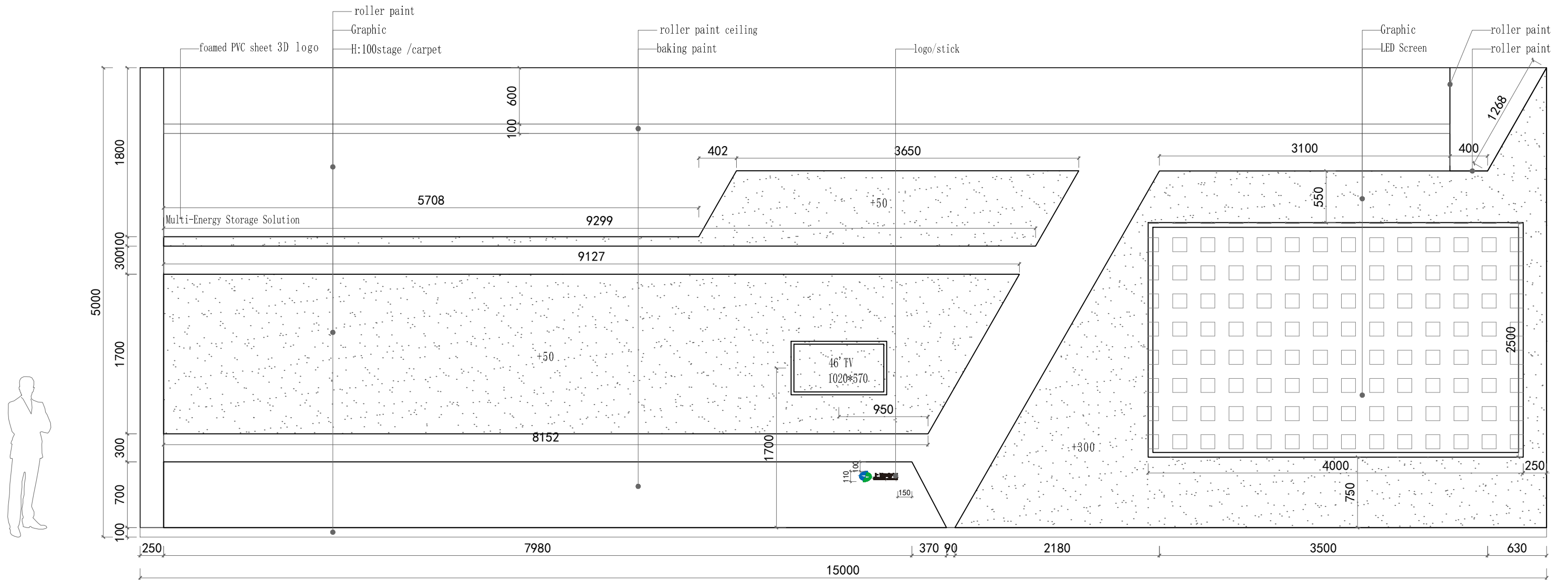

Elevation 03-04

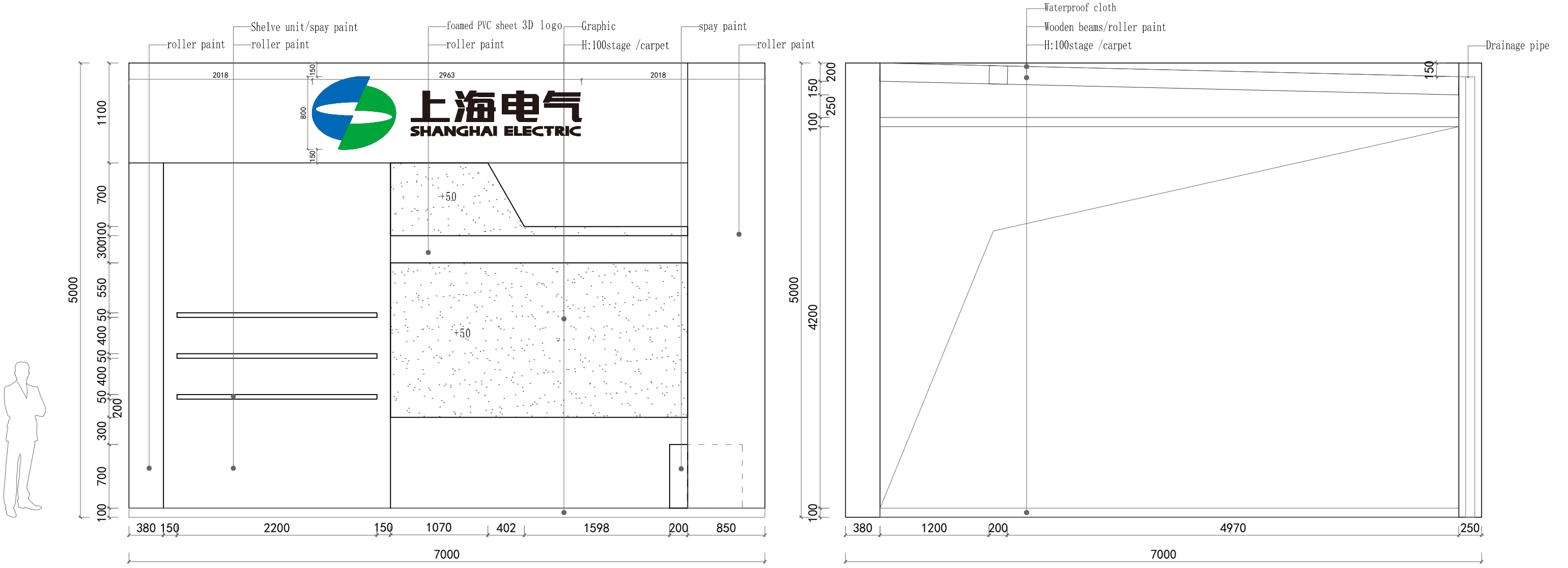

Elevation 05

Graphic

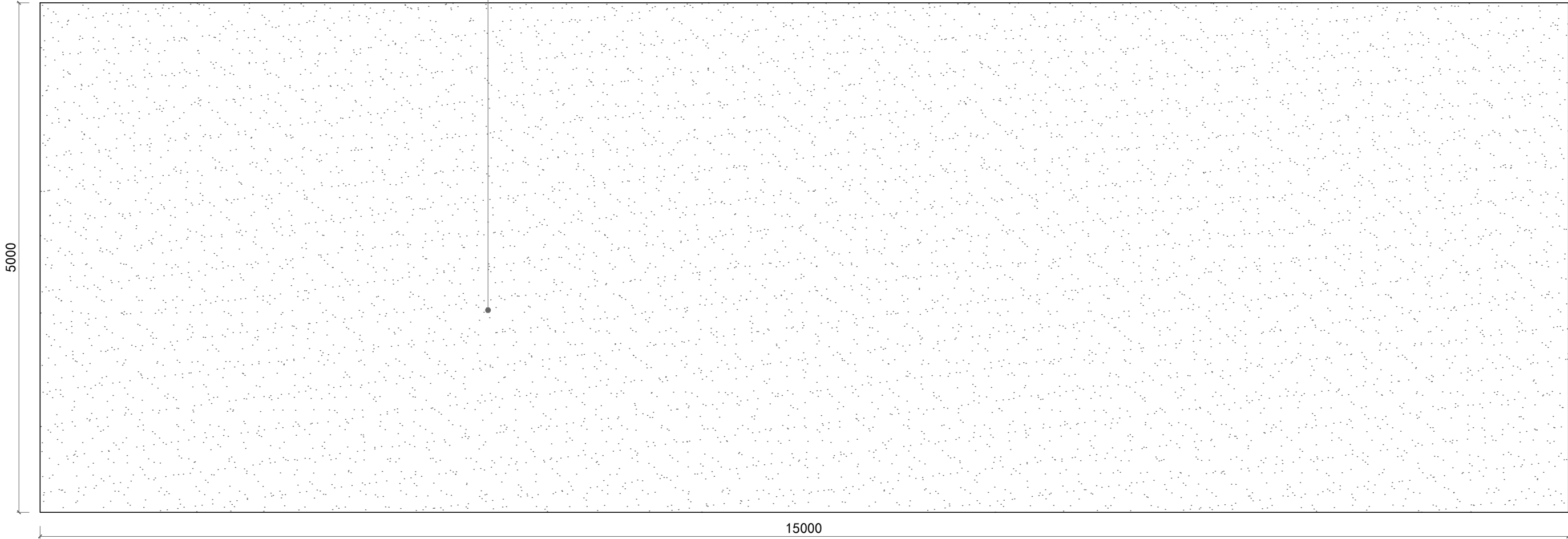

Elevation 06-08

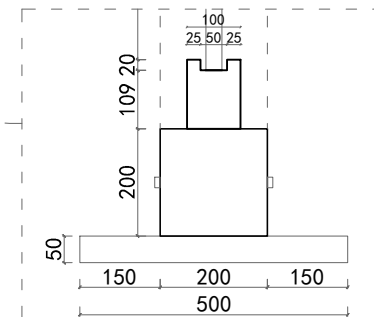
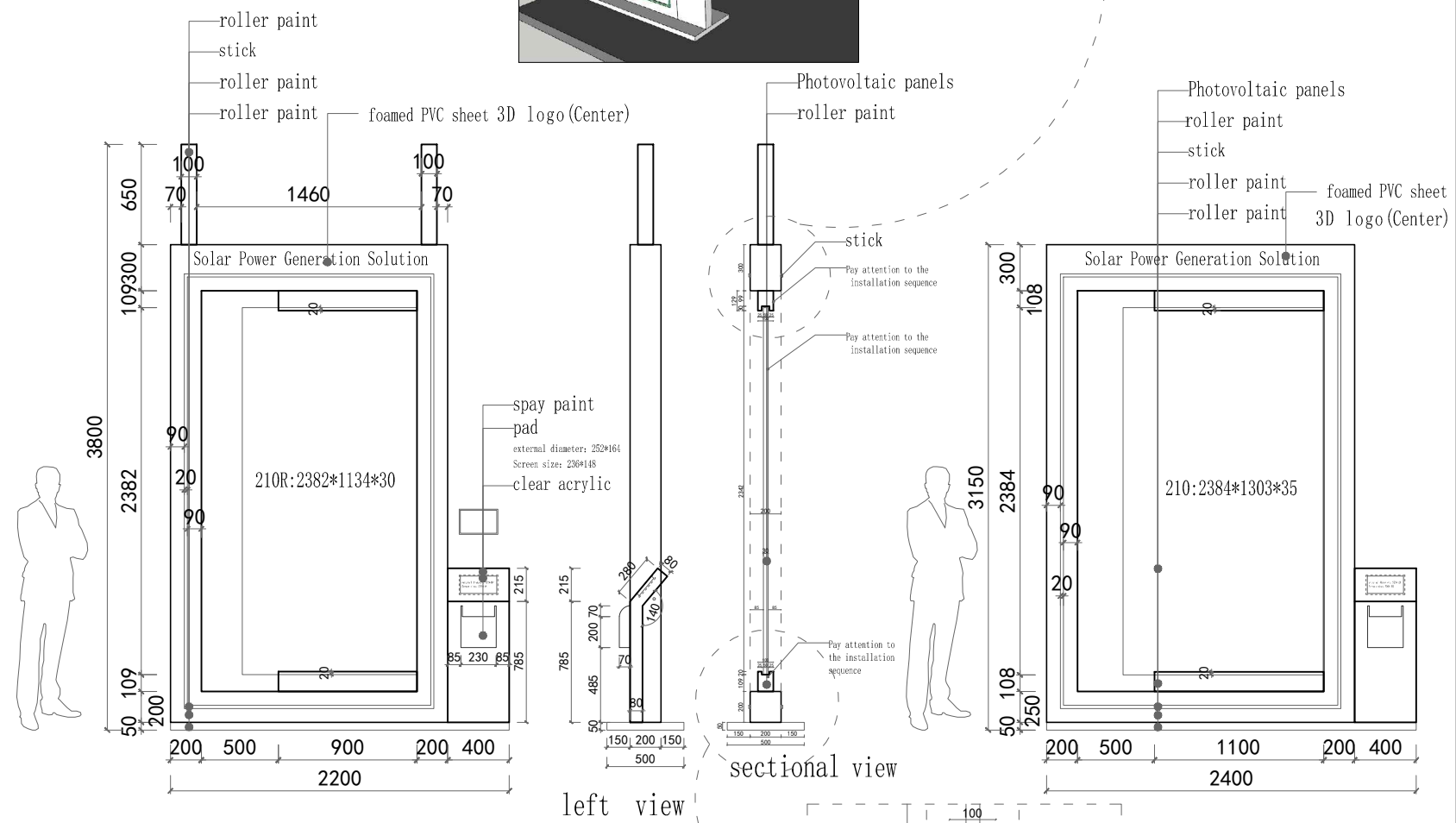
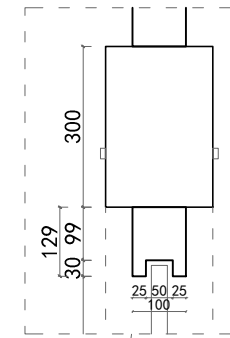
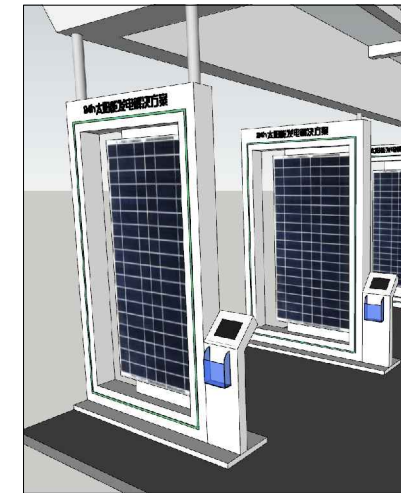
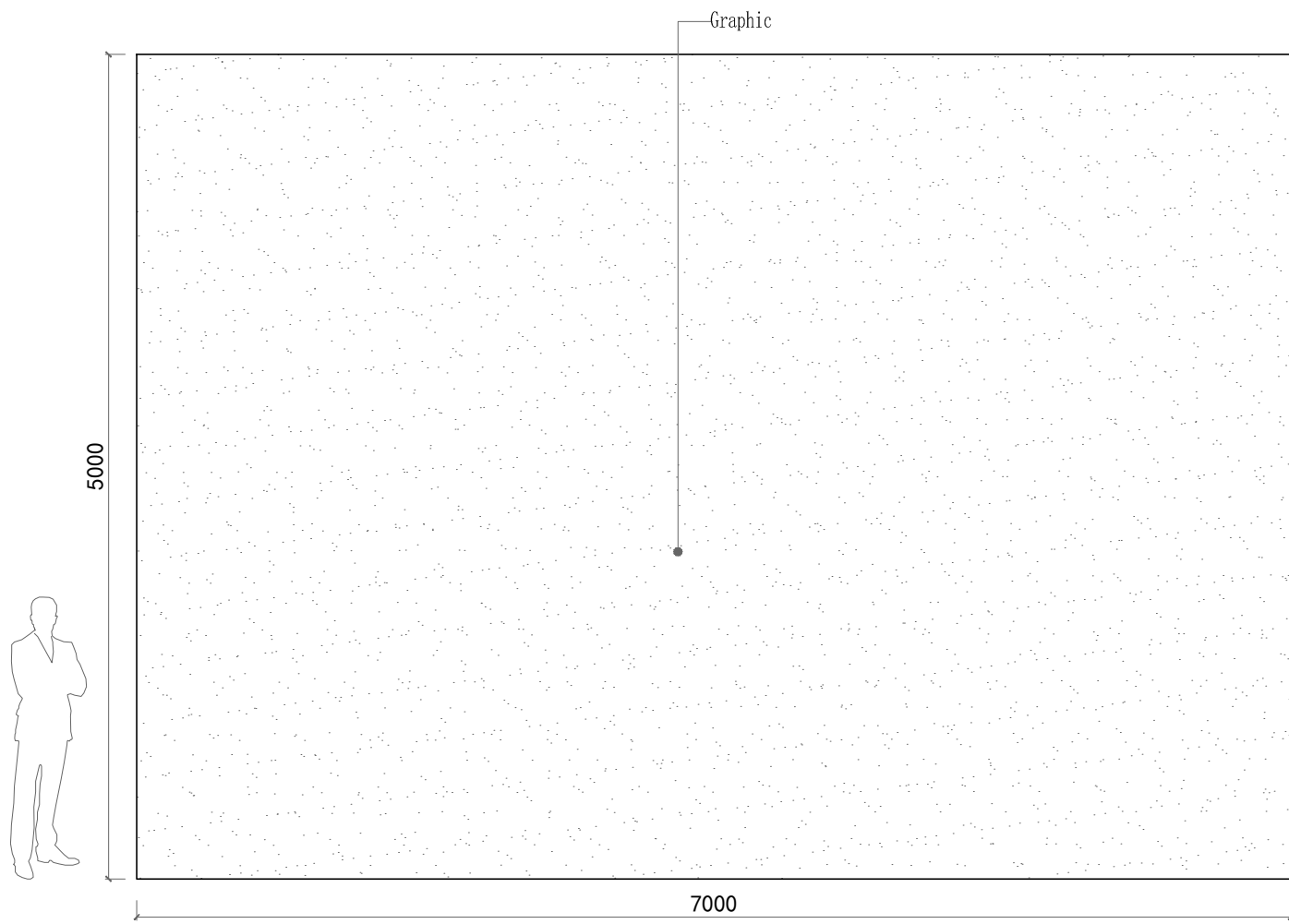

Elevation 09-10

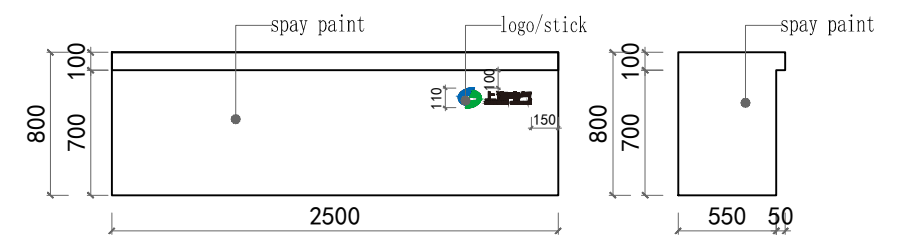
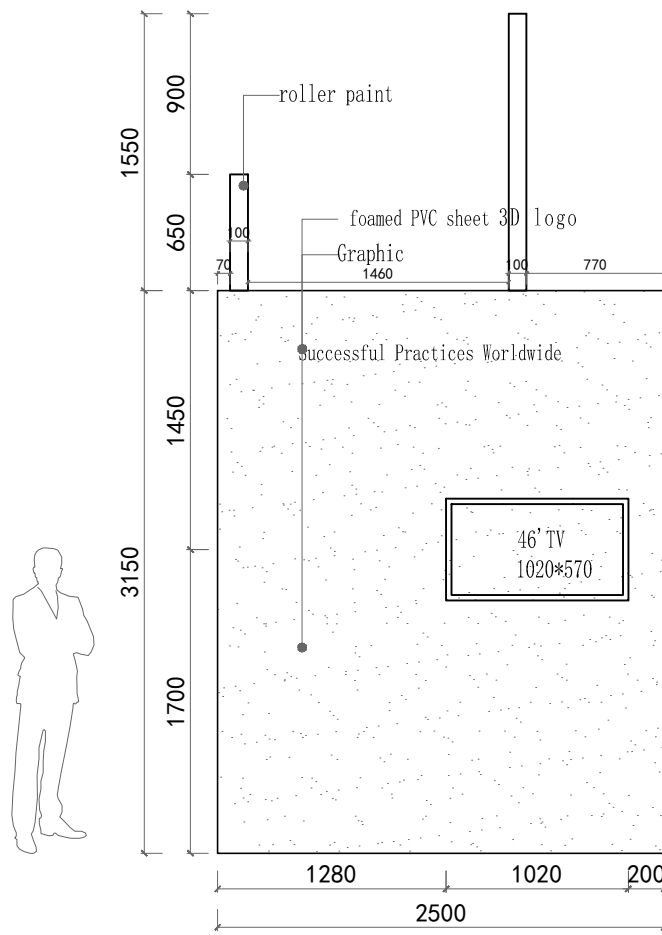
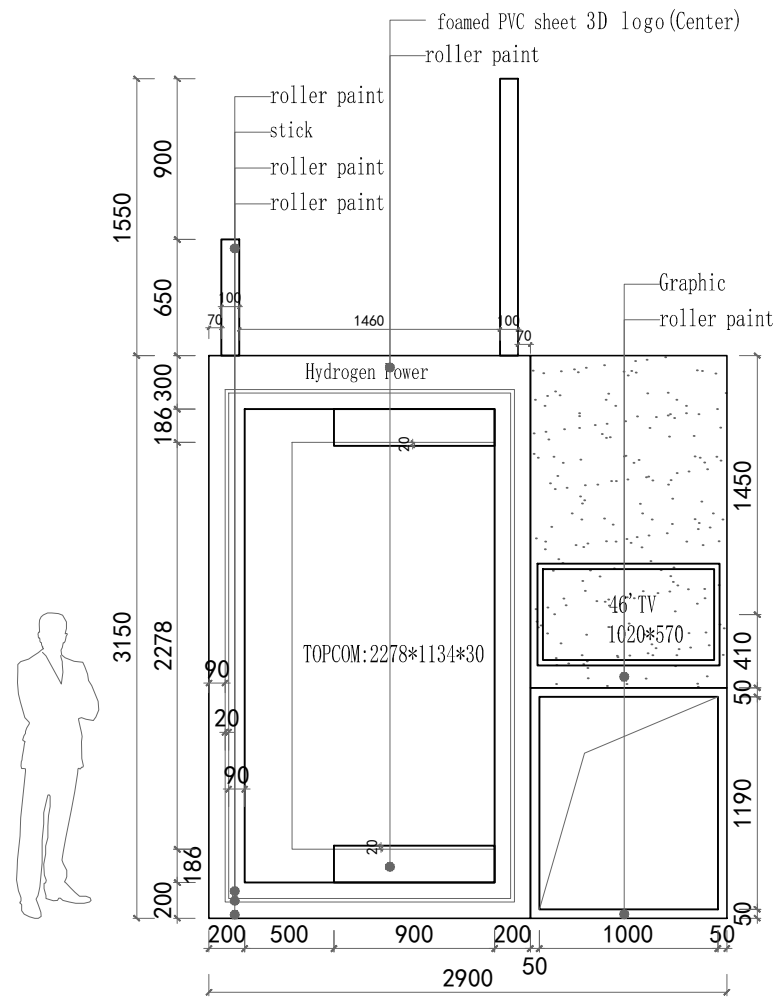

Elevation 11

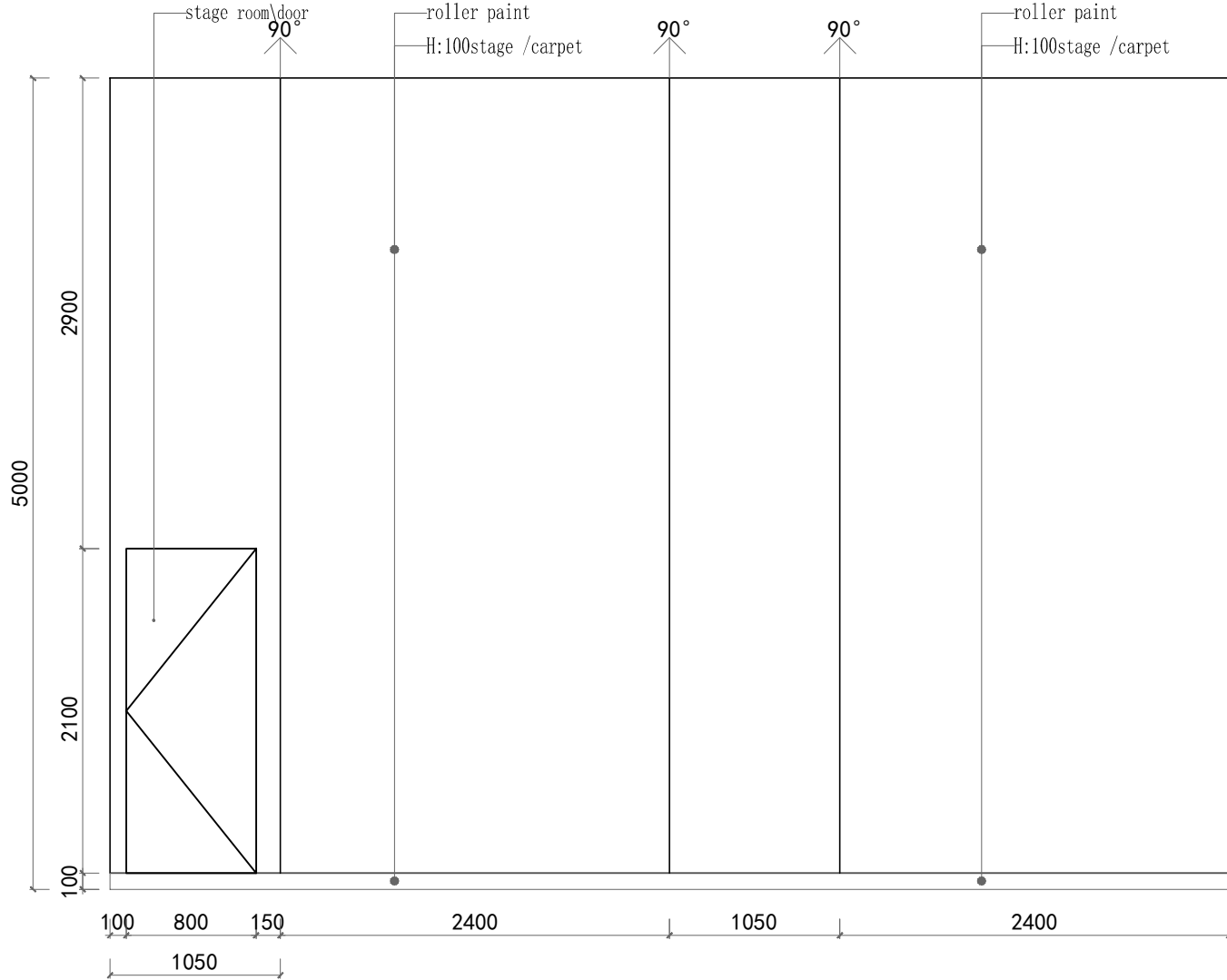

Elevation 12

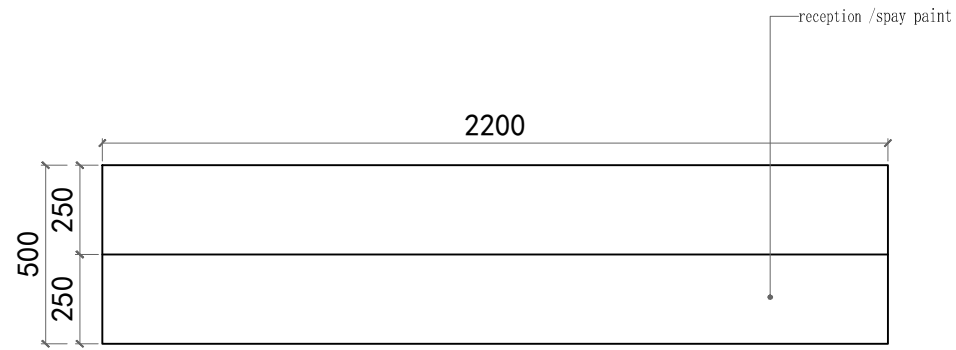

top view

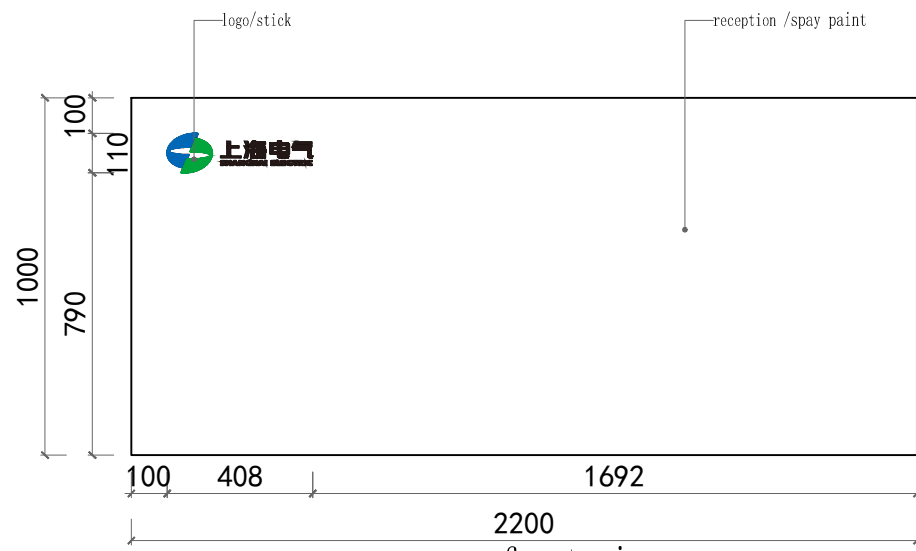

front view

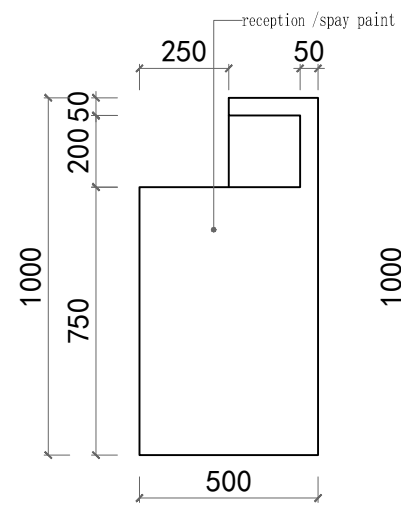

left view

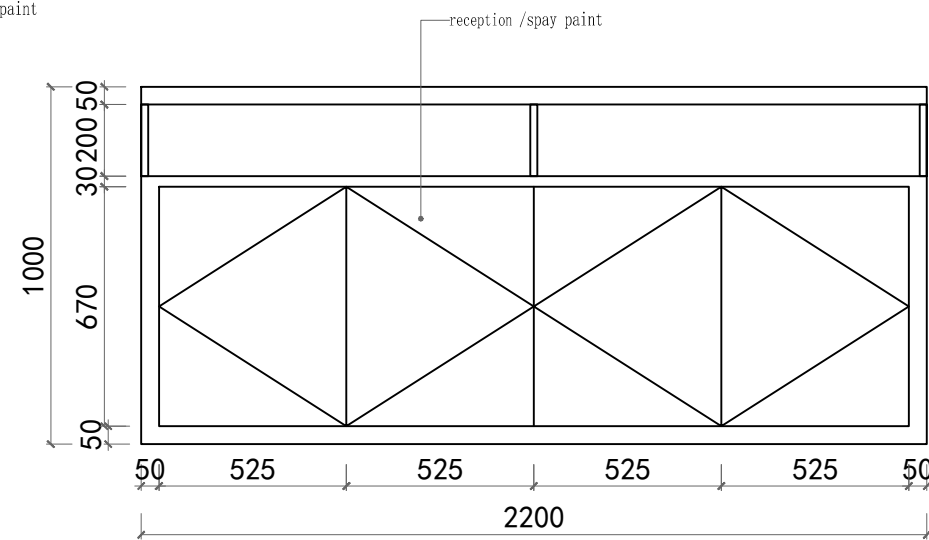

rear view

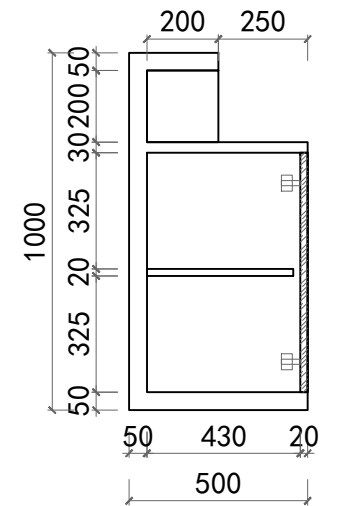

sectional view