



Moscovskaya - Milan

Build Pack - 2024

Andy Fennhiggins

andyfh@chorus.london

V01 - 07/01/23
- First Issue - Basic Dimensions and Material Specification

Plan

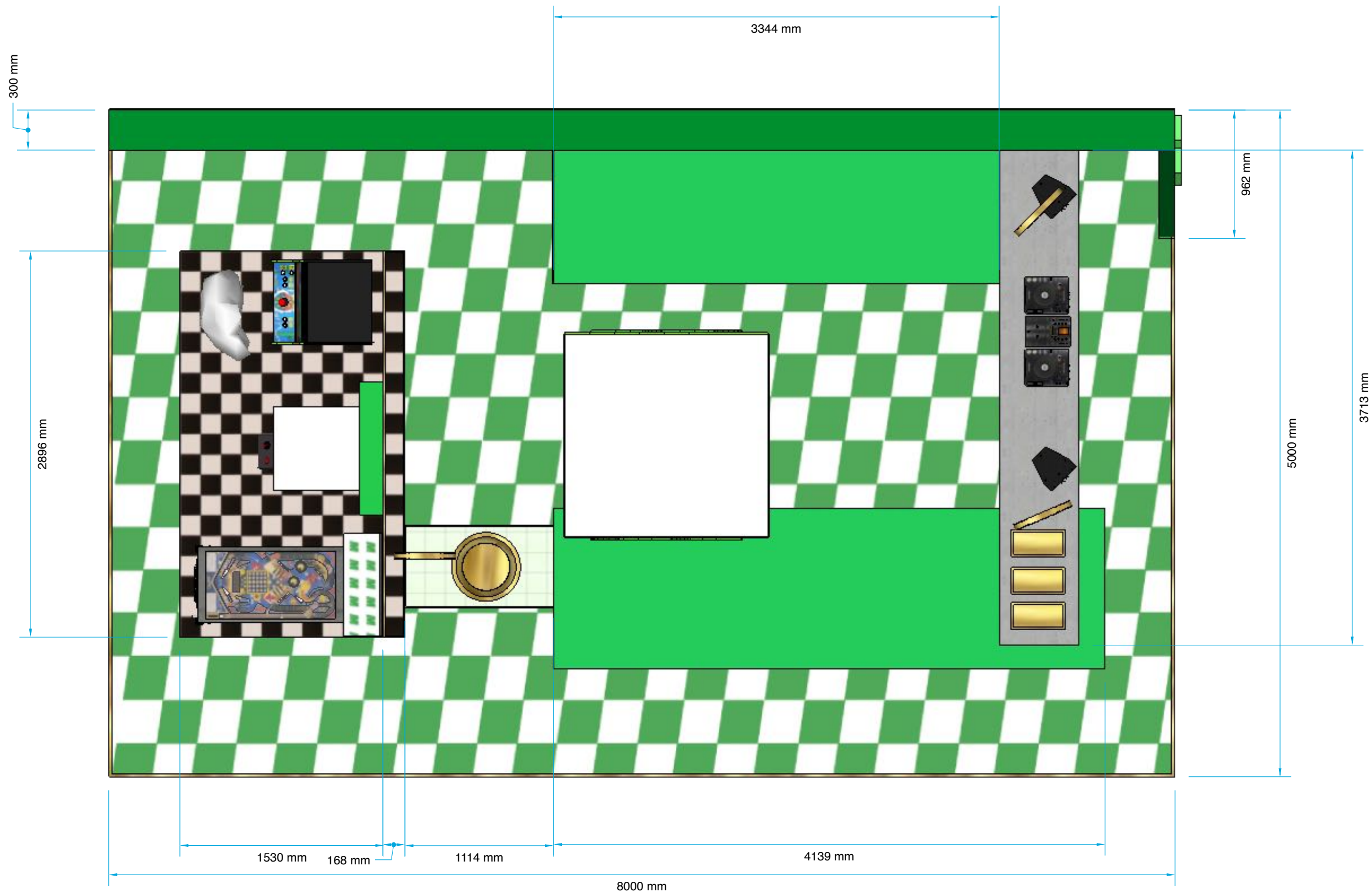

Scale 1:32
@ A3

ISO Views

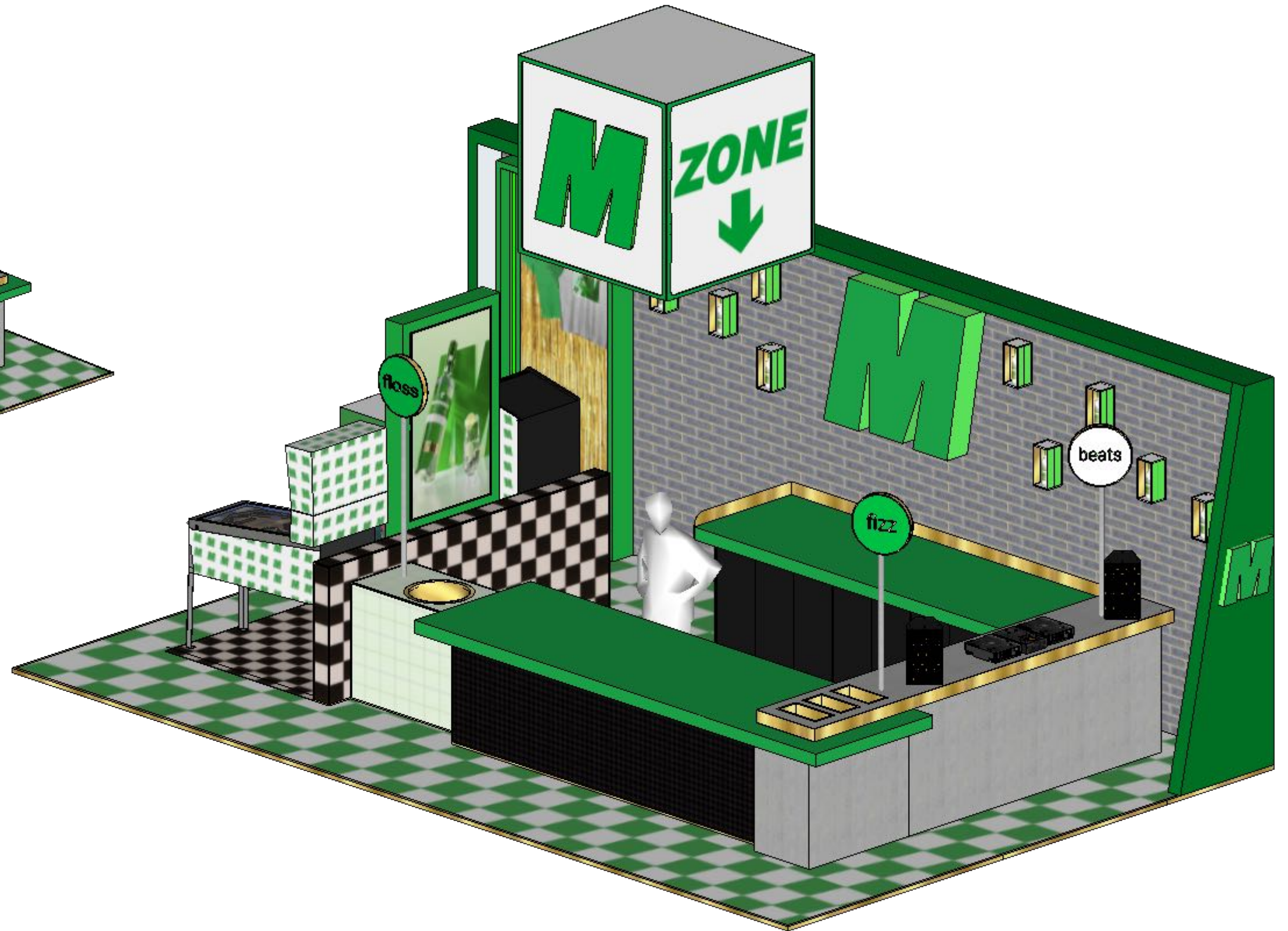





Item Codes

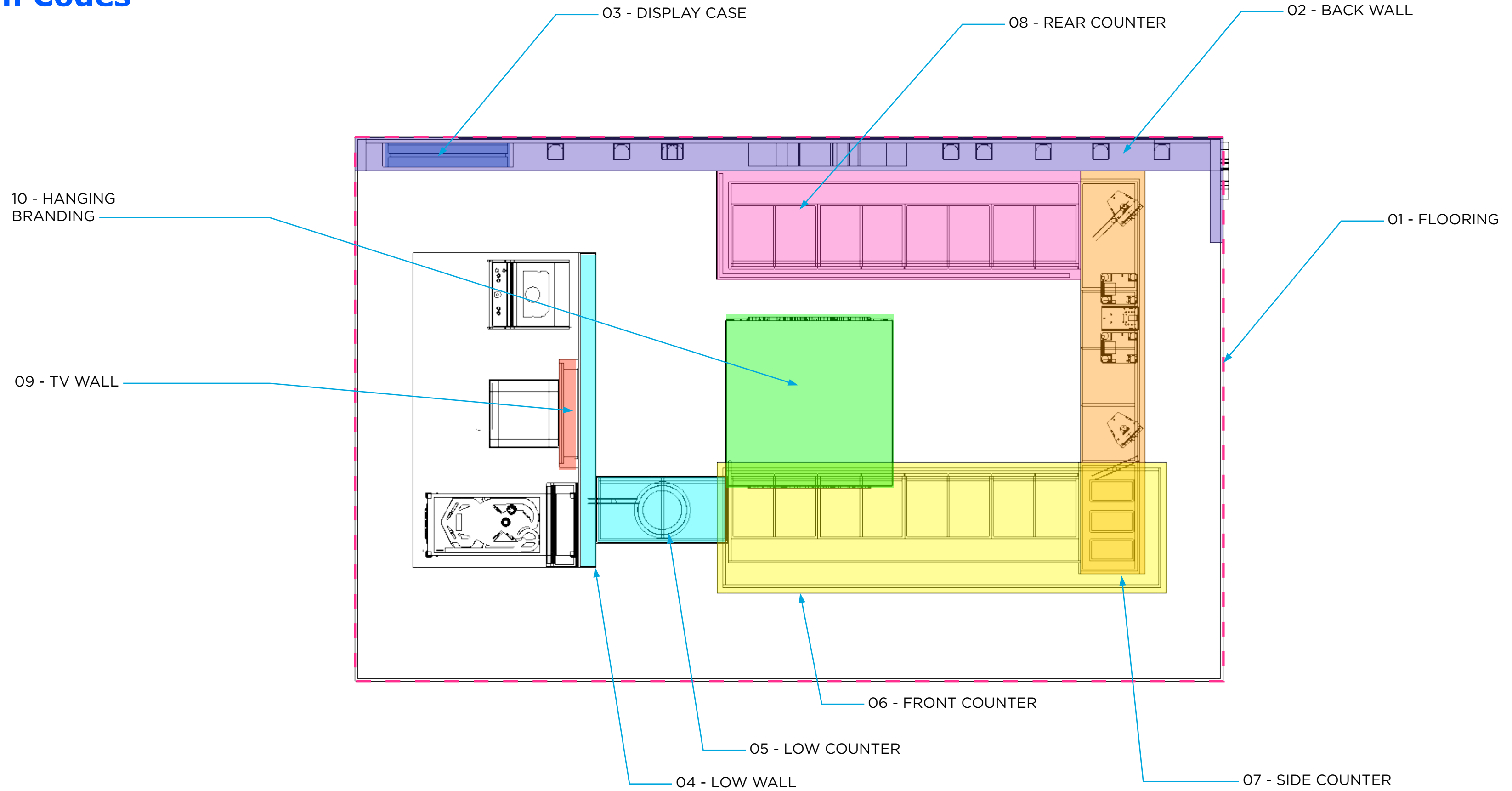

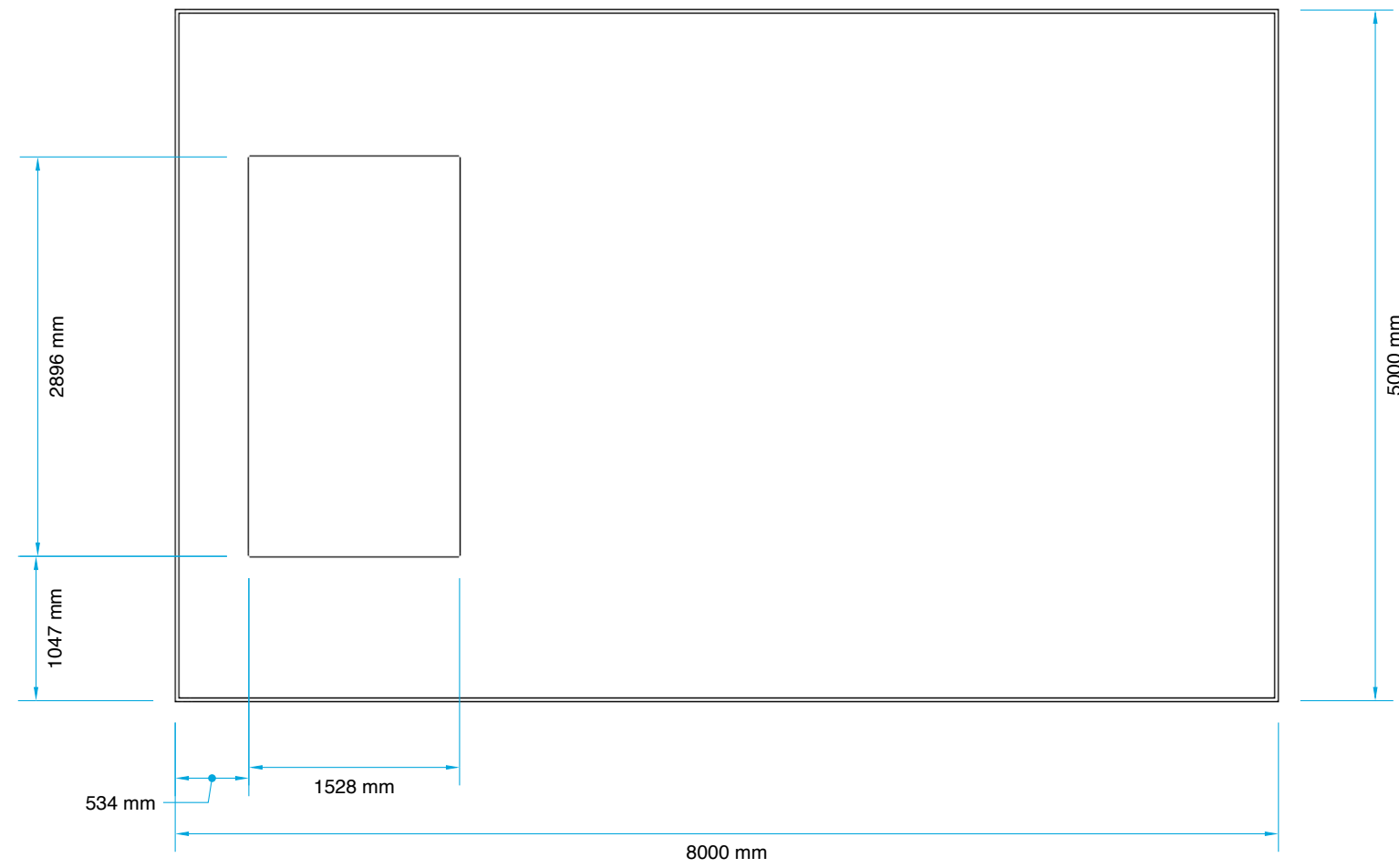

BLACK AND WHITE PATTERNED VINYL FLOORING INSET

GREEN AND WHITE PATTERN TO VINYL FLOOR - FITTED ONTO 18mm BATTENS AND 18mm CHIPBOARD PANELS

25MM X 25MM BRASS ANGLE TO EDGES

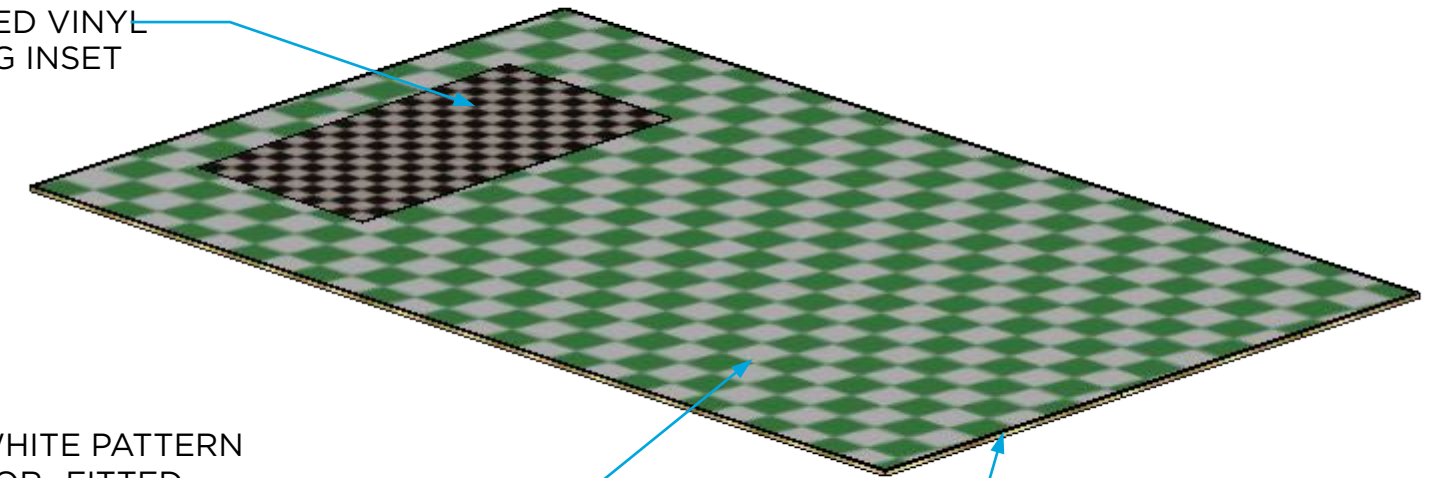

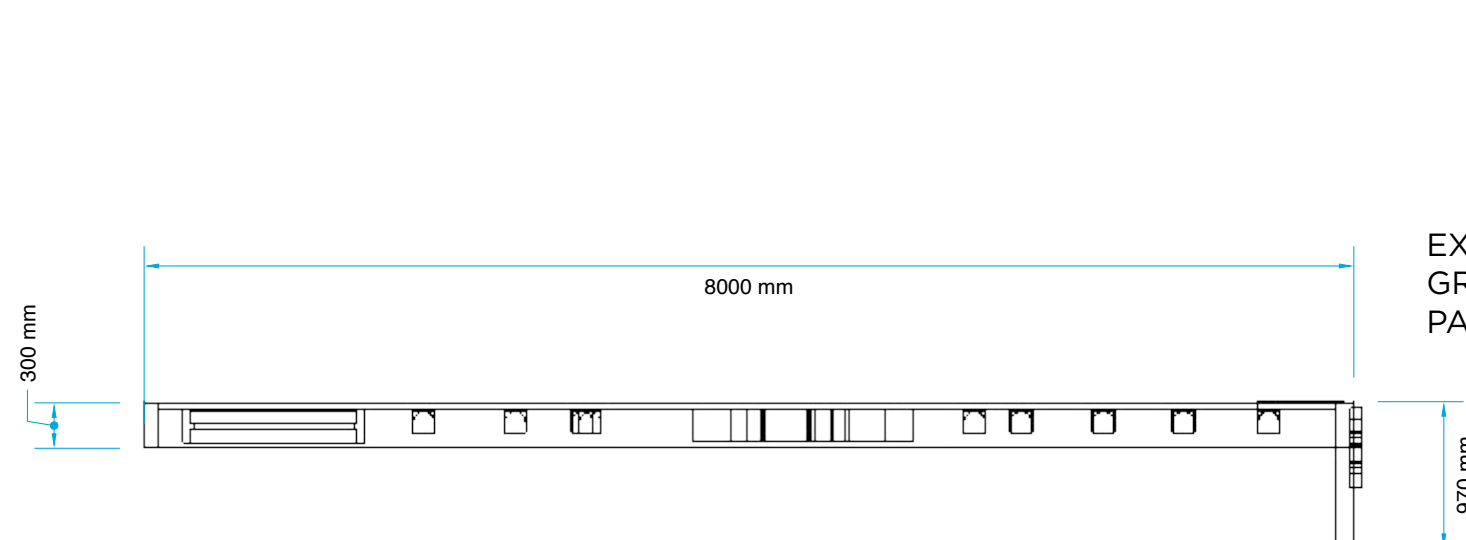

03 DISPLAY CASE (see next page)

EXTERIOR FACES 2 PAC GREEN (RAL REF) PAINT FINISH

INSIDE FACES AND UNDER TOP TO INCLUDE LED LIGHTING BEHIND OPAL ACRYLIC

BACK WALL WITH FAKE GREY BRICKS WITH WHITE GROUT BETWEEN TO CREATE A TEXTURED FINISH

ANGLED END WALL ADDS EXTRA STABILITY + SPACE FOR BRANDING WITH A 3D 'M' LOGO

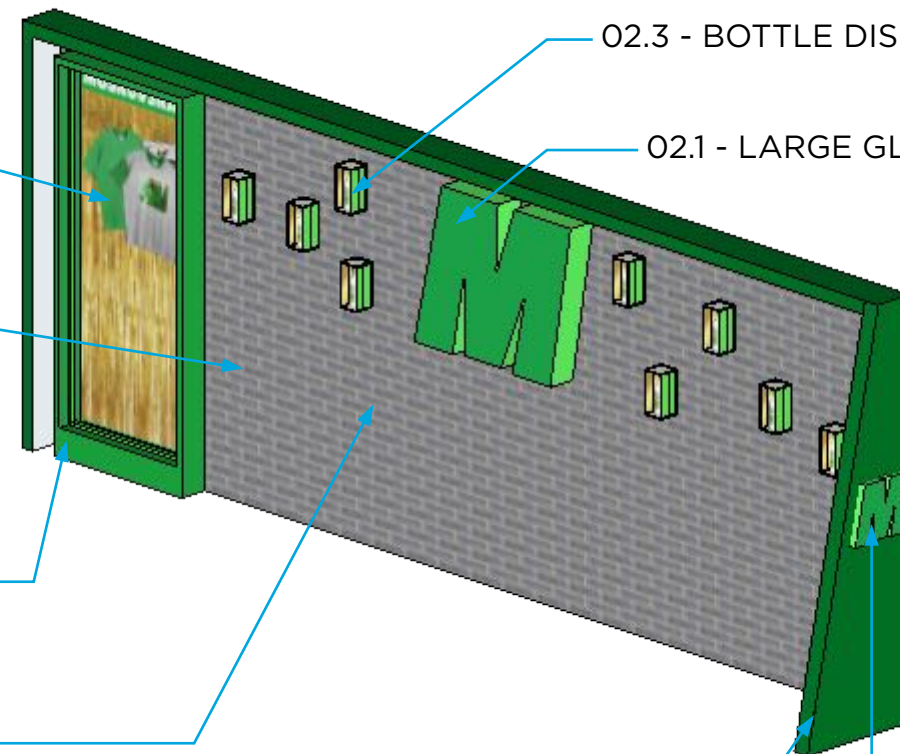

02.3 - BOTTLE DISPLAY SHELF

02.1 - LARGE GLOWING M LOGO

02.2 SMALL GLOWING M LOGO

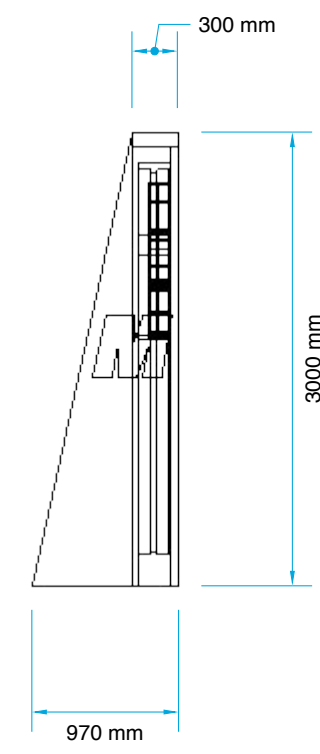
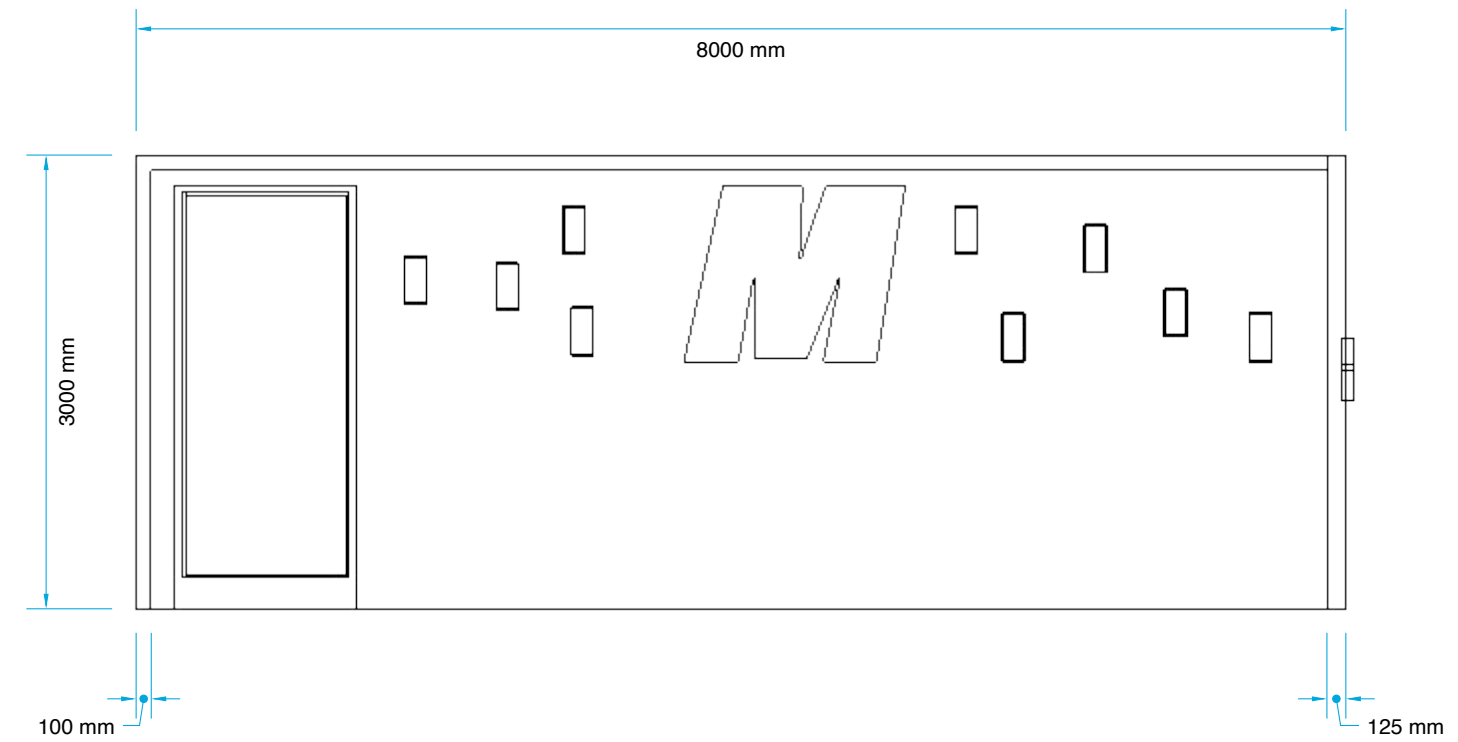



FRONT FACE OPAQUE
(RAL MATCHED) ACRYLIC

LED LIGHTING
EMITS THROUGH
ACRYLIC SIDES

FIXINGS TO MOUNT TO WALL

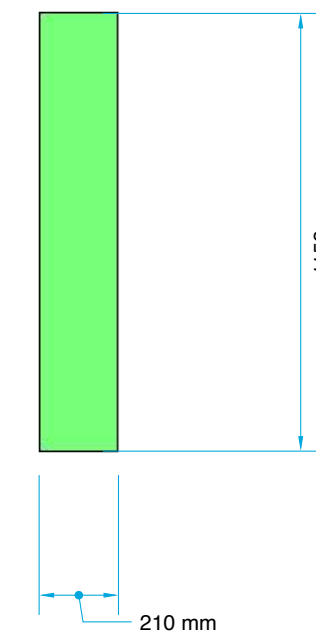
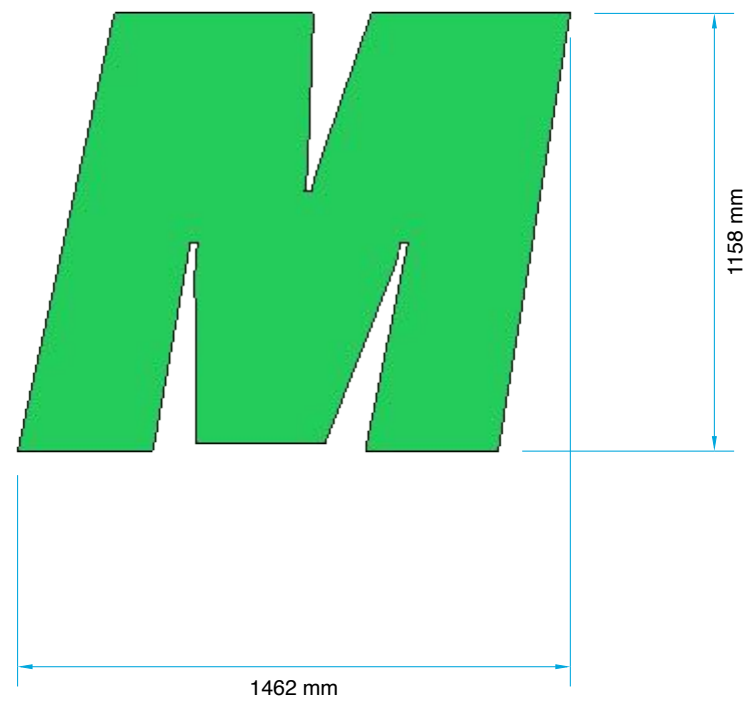
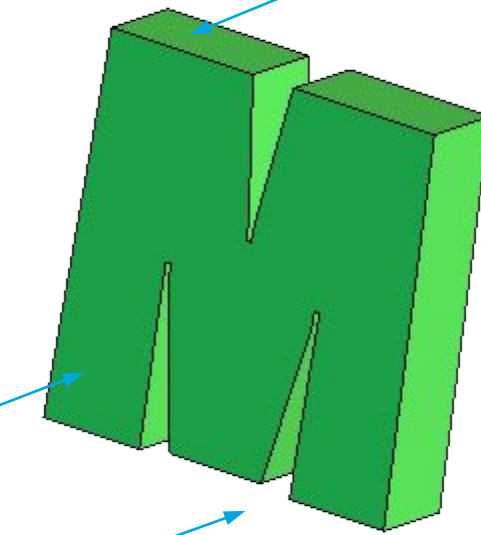

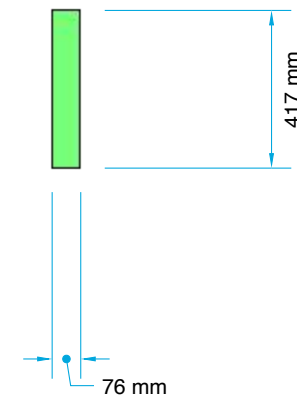
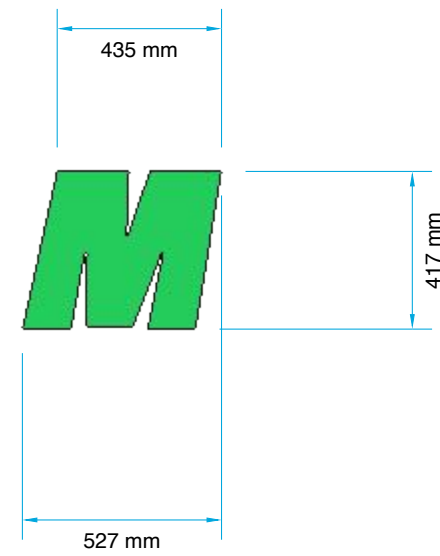
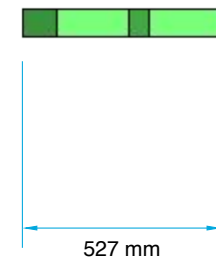

FRONT FACE OPAQUE
(RAL MATCHED) ACRYLIC

FIXINGS TO MOUNT TO WALL

LED LIGHTING
EMITS THROUGH
ACRYLIC SIDES

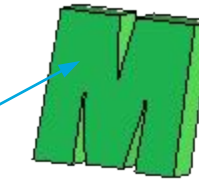

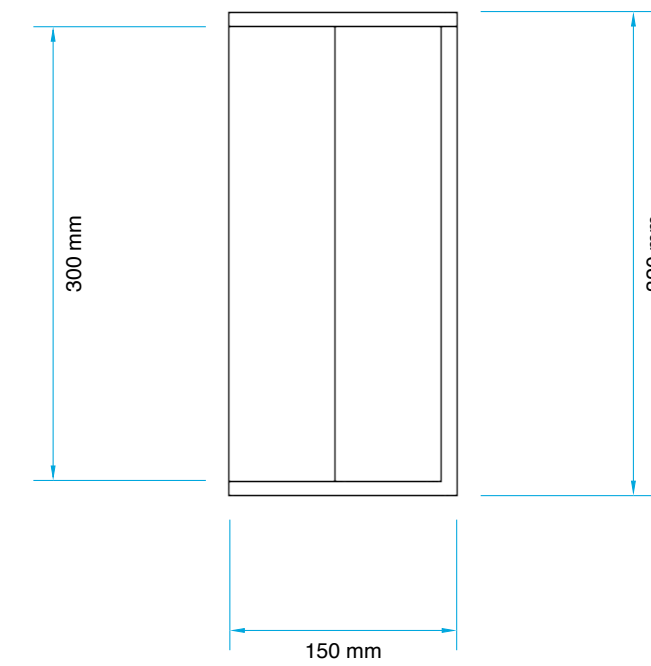
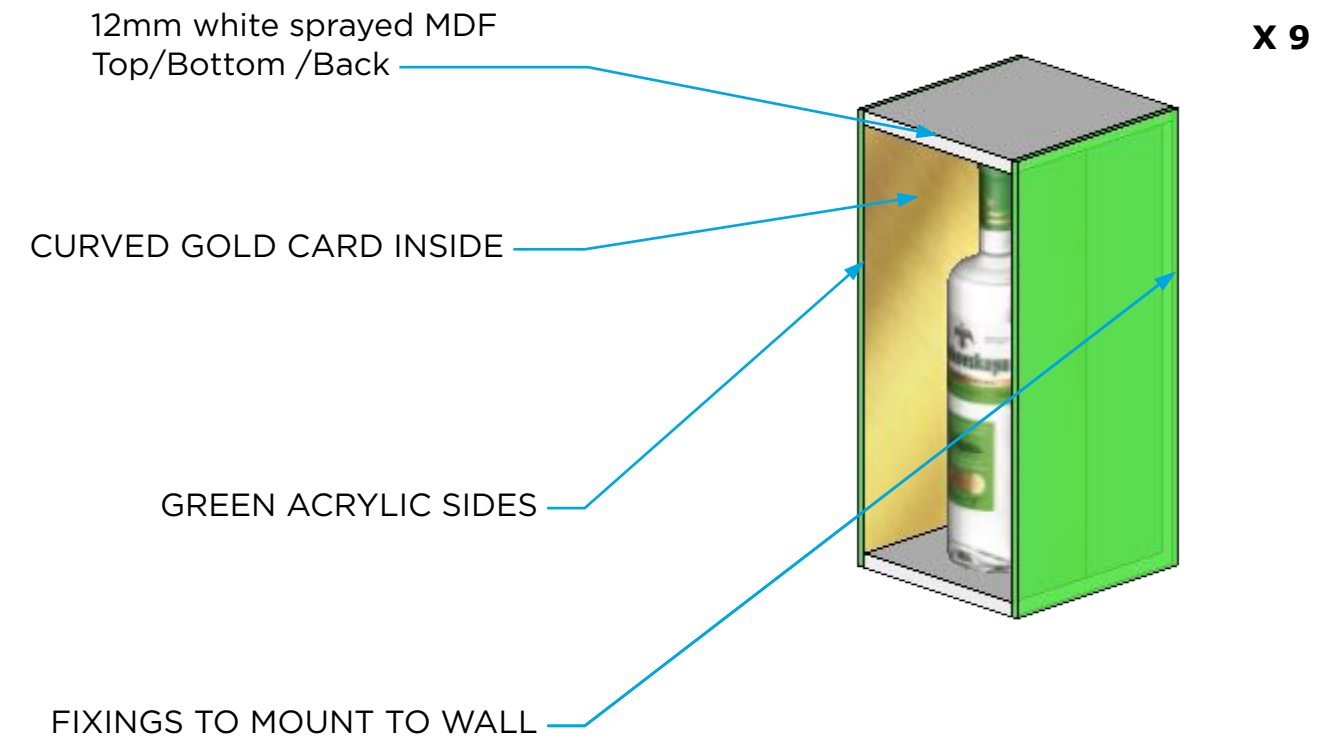
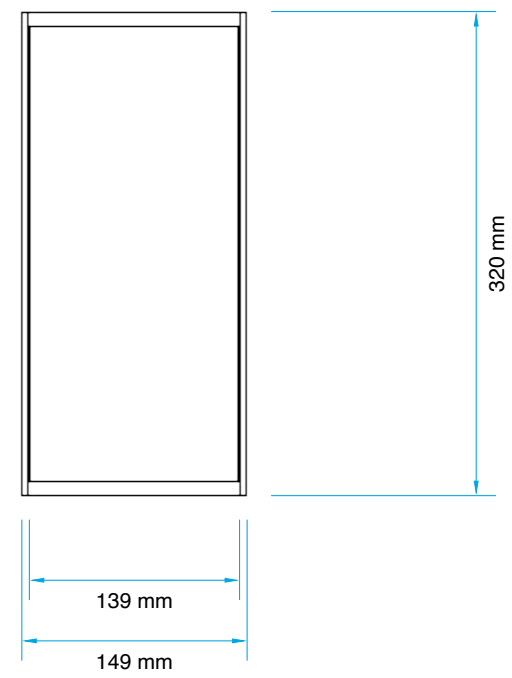
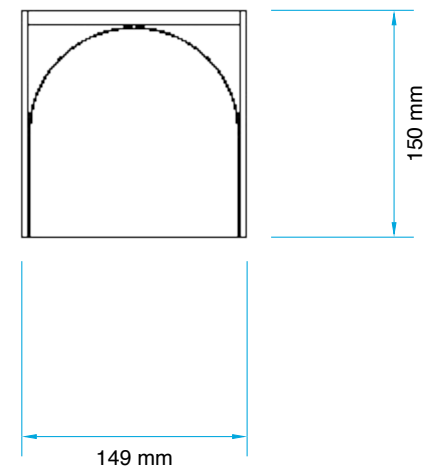

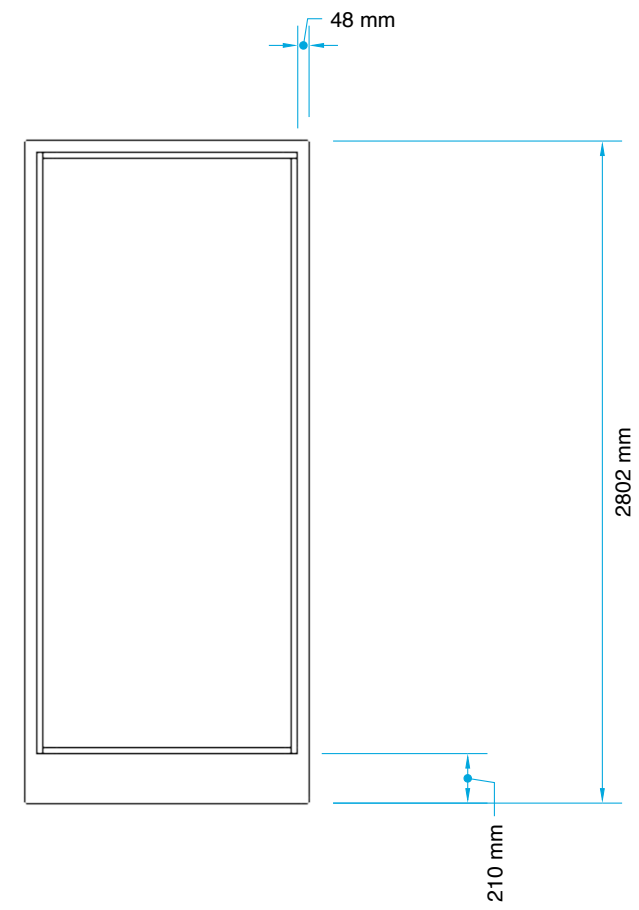
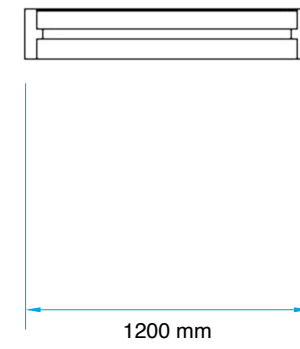

ILLUMINATED LOGO

18mm (RAL GREEN)
sprayed MDF CARCASS

LED STRIP LIGHTING AROUND SIDES /
TOP / BOTTOM

GOLD TINSEL STYLE STRIPS
TO BACK WALL

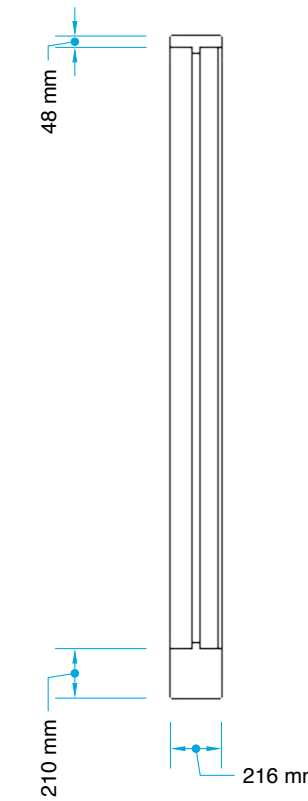

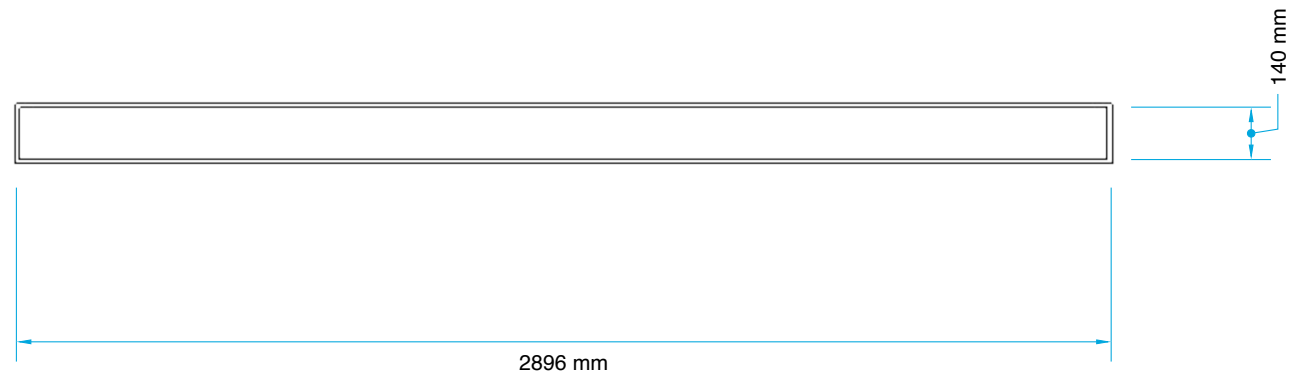

BLACK AND WHITE 150MM TILES
WALL EDGES HAVE 10MM BRASS/GOLD
CORNER TRIM

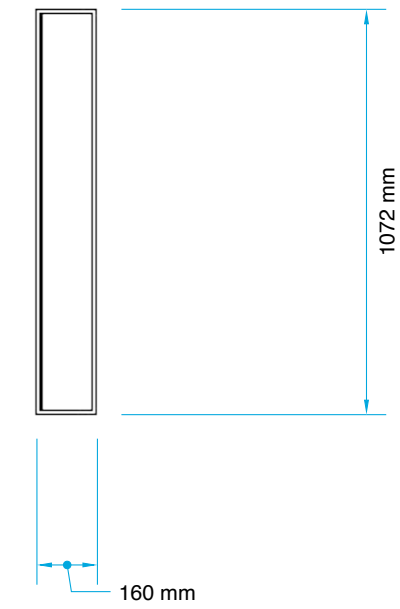
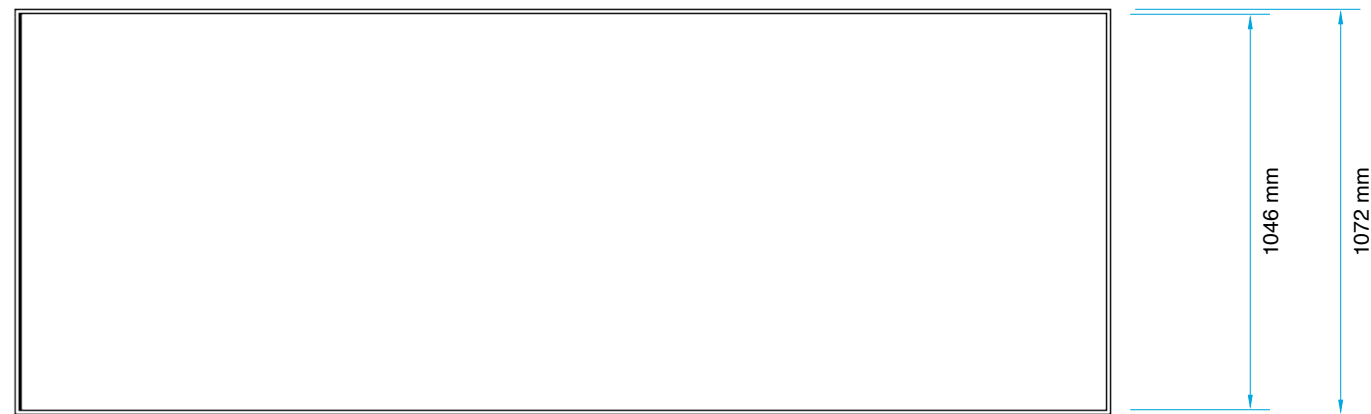
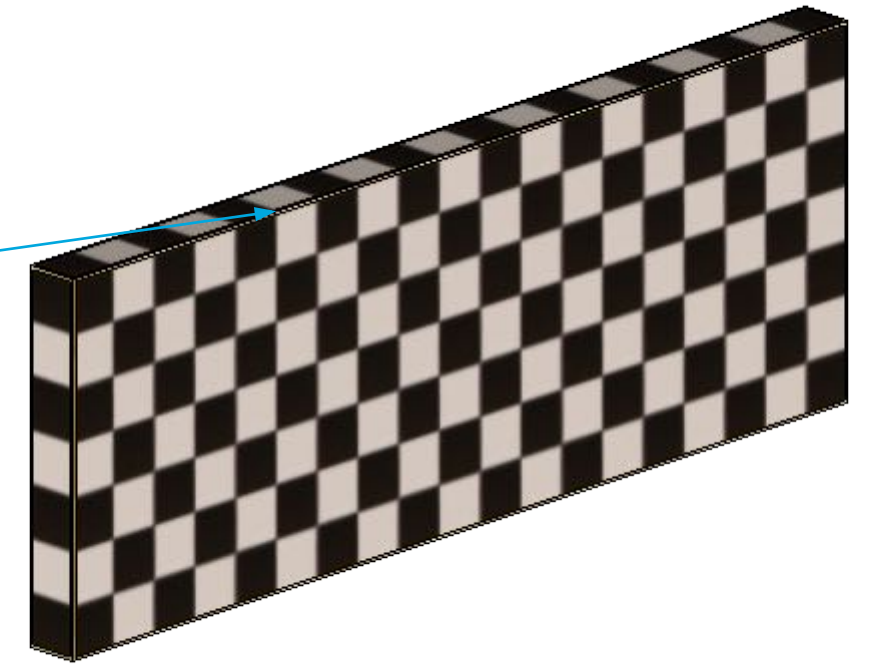

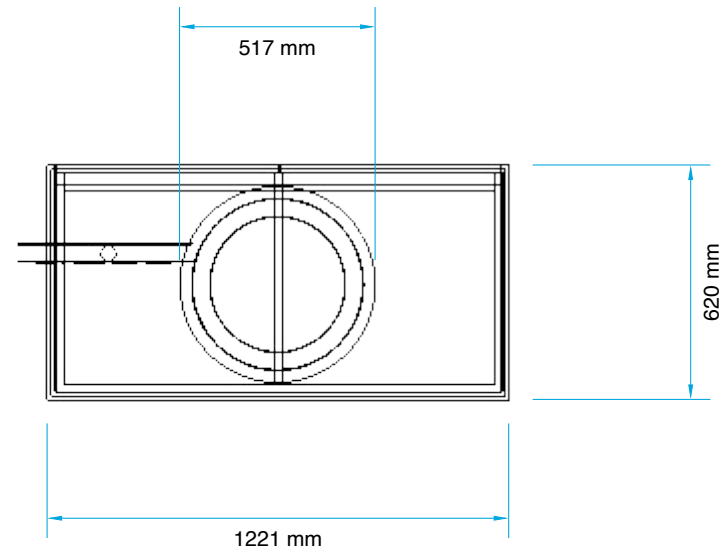

1.5m pole with lollypop sign on top -
 Brass edge/ Green acrylic discs and
 Fret cut 100mm high text

WHITE 150MM TILES WITH GREY GROUT
 CORNERS/EDGES HAVE 10MM BRASS/GOLD
 CORNER TRIM
 UNIT HAS CIRCULAR CUTOUT FOR BRASS
 SINK/BOWL UNIT

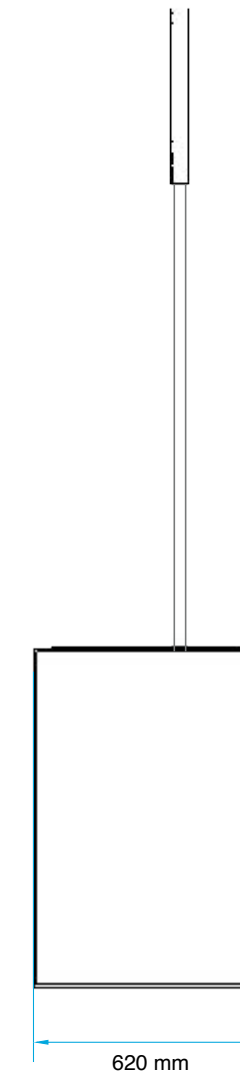
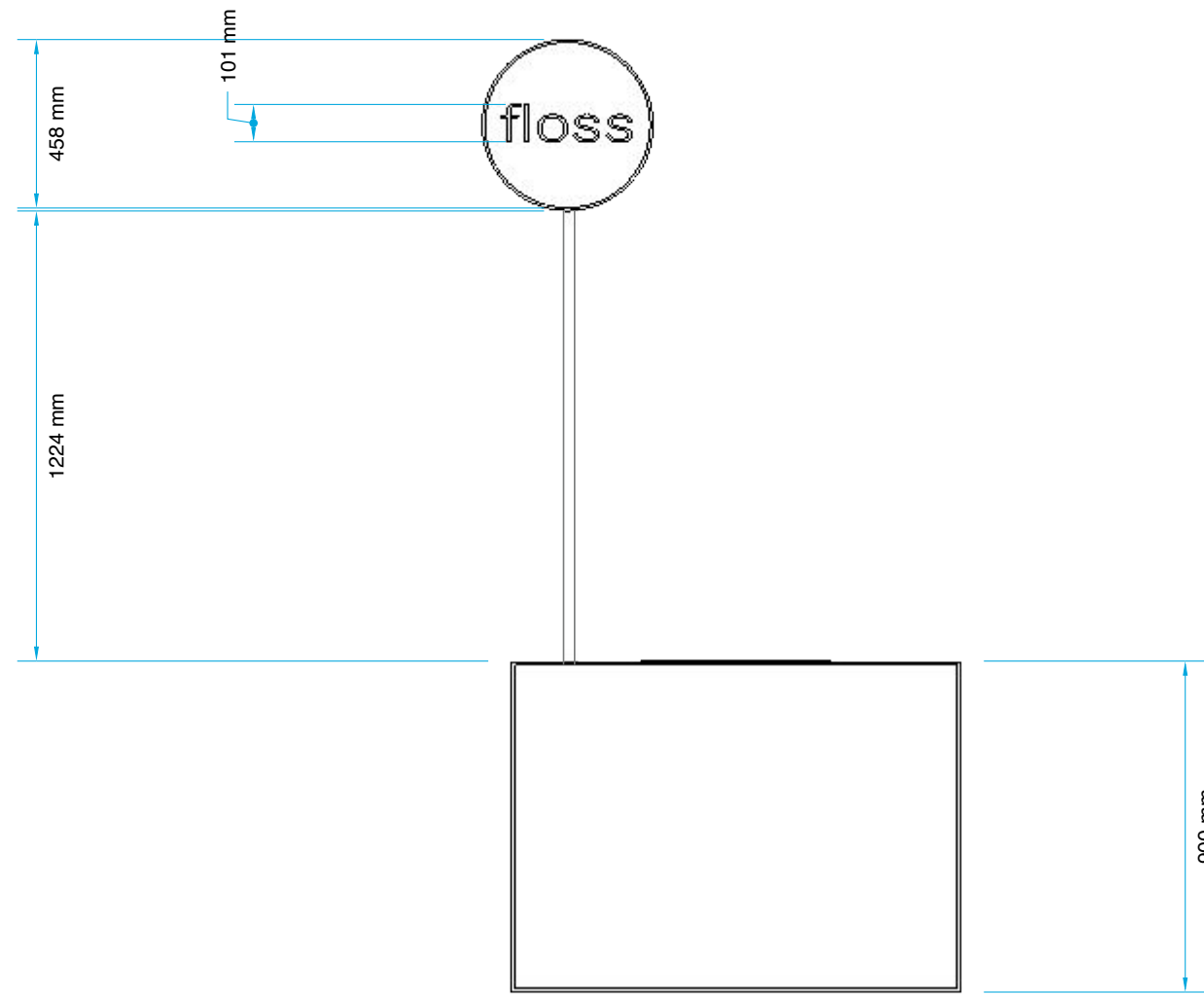
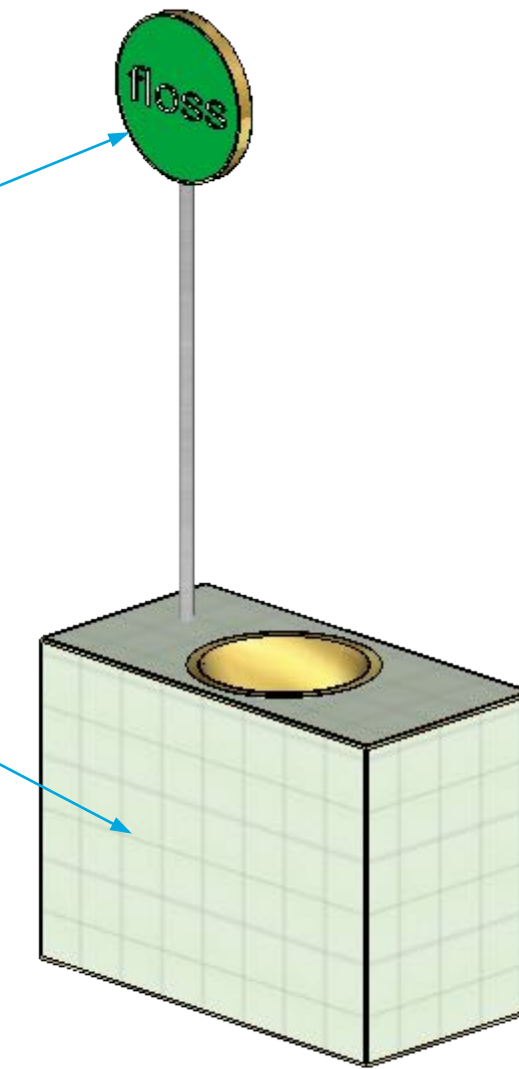

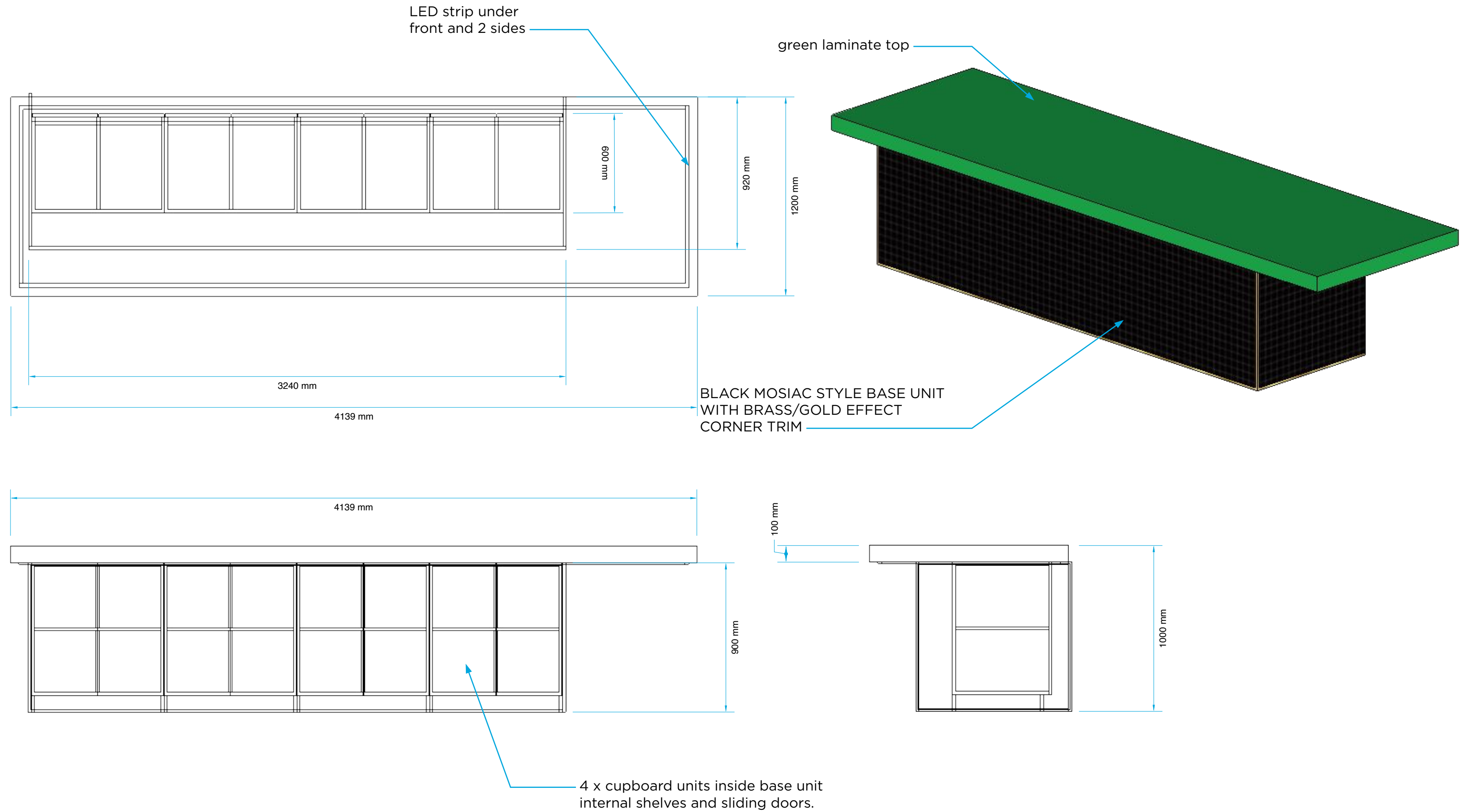

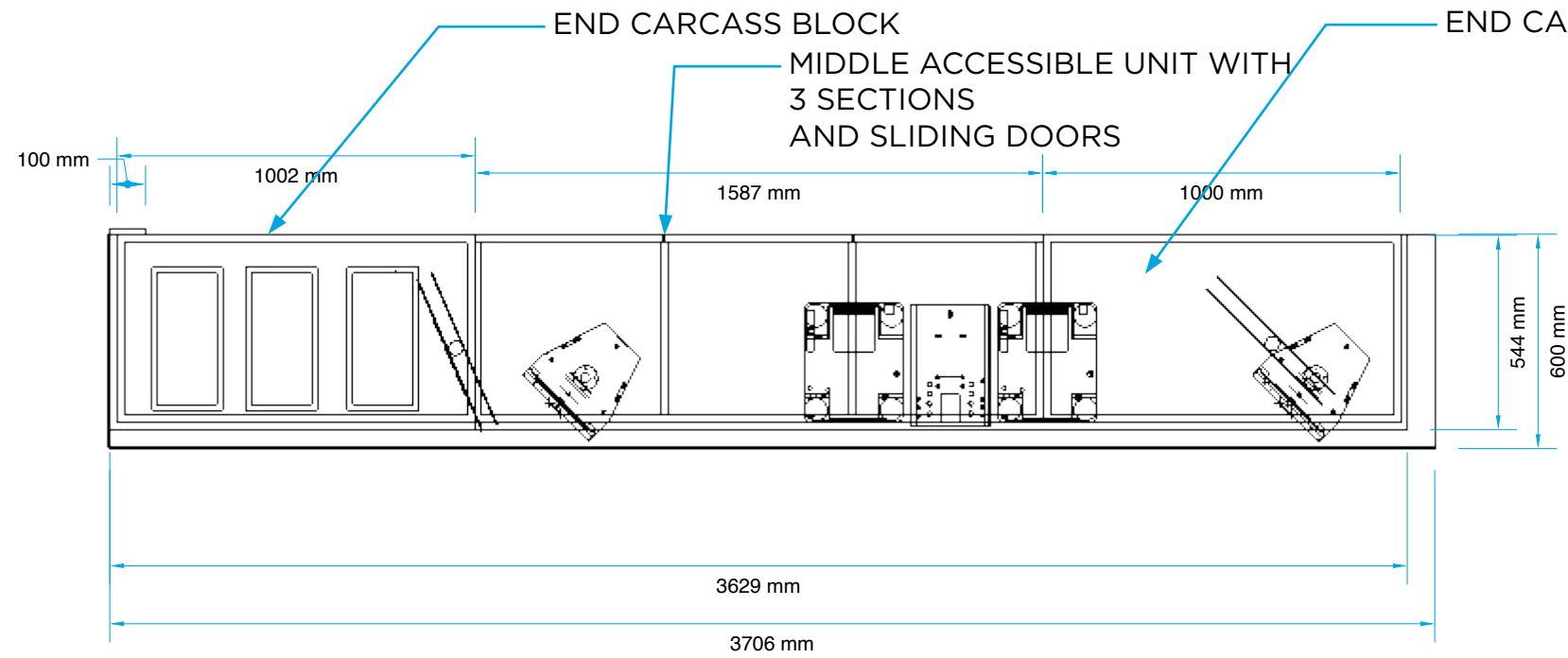

CONCRETE LAMINATE WORKTOP WITH BRASS EDGING
3 X BRASS TROUGH INSERTS

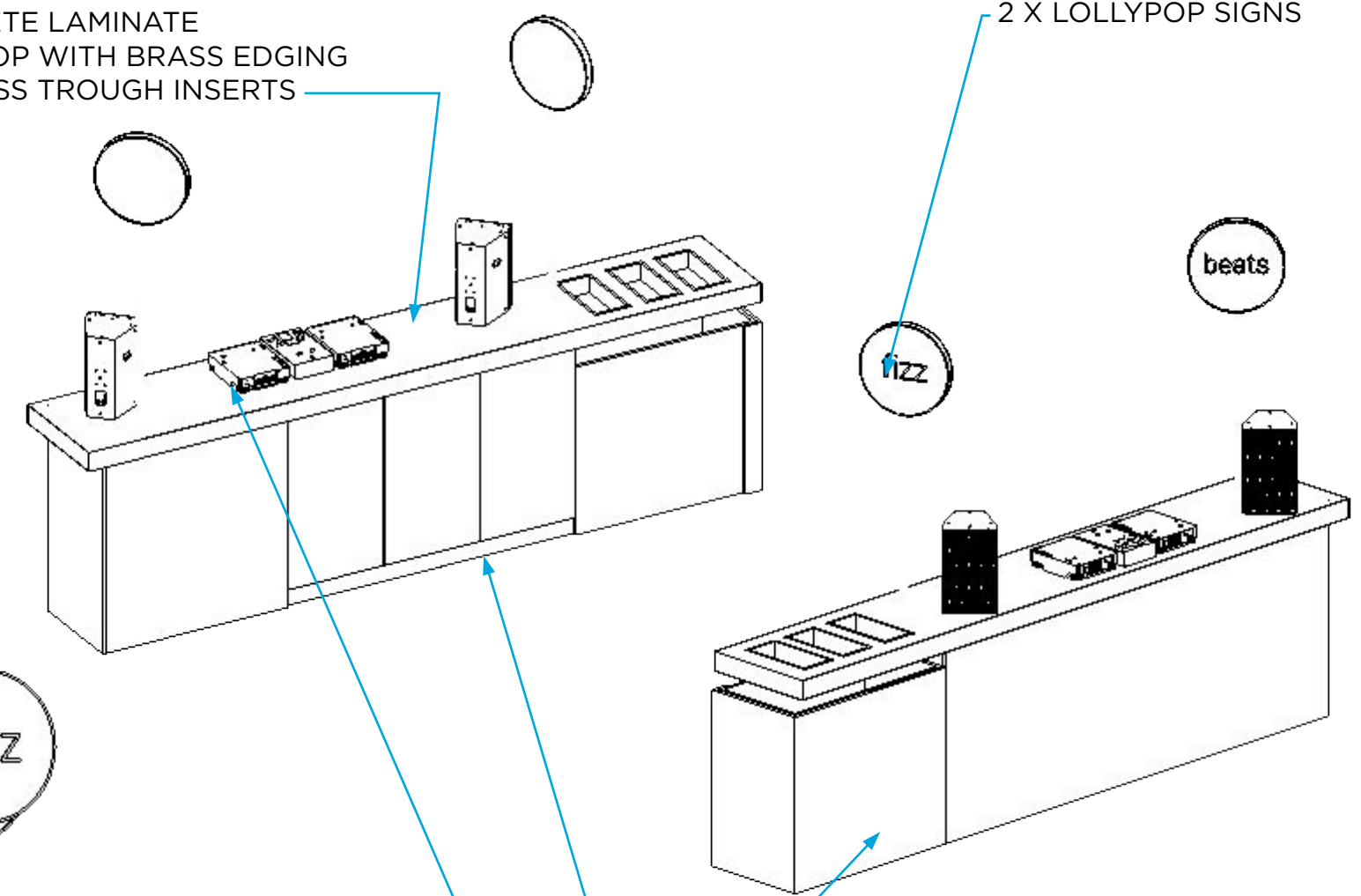

CONCRETE EFFECT LAMINATE UNITS (THIS END UNIT MADE SEPARATE TO ALLOW FOR FRONT WORKTOP TO FIT IN)

3 X BASE UNITS (CENTRAL UNIT HAS STORAGE BEHIND SLIDING DOORS) WITH CONCRETE EFFECT LAMINATED FRONT AND SIDE PANELS

HOLES AND CABLE MANAGEMENT WILL BE REQUIRED FOR DJ BOOTH, SPEAKERS AND LOLLYPOP SIGNS

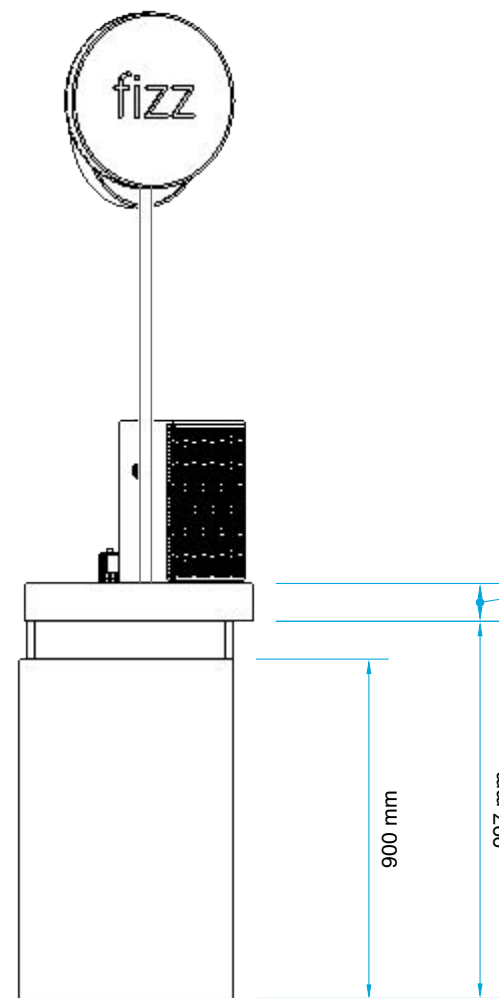
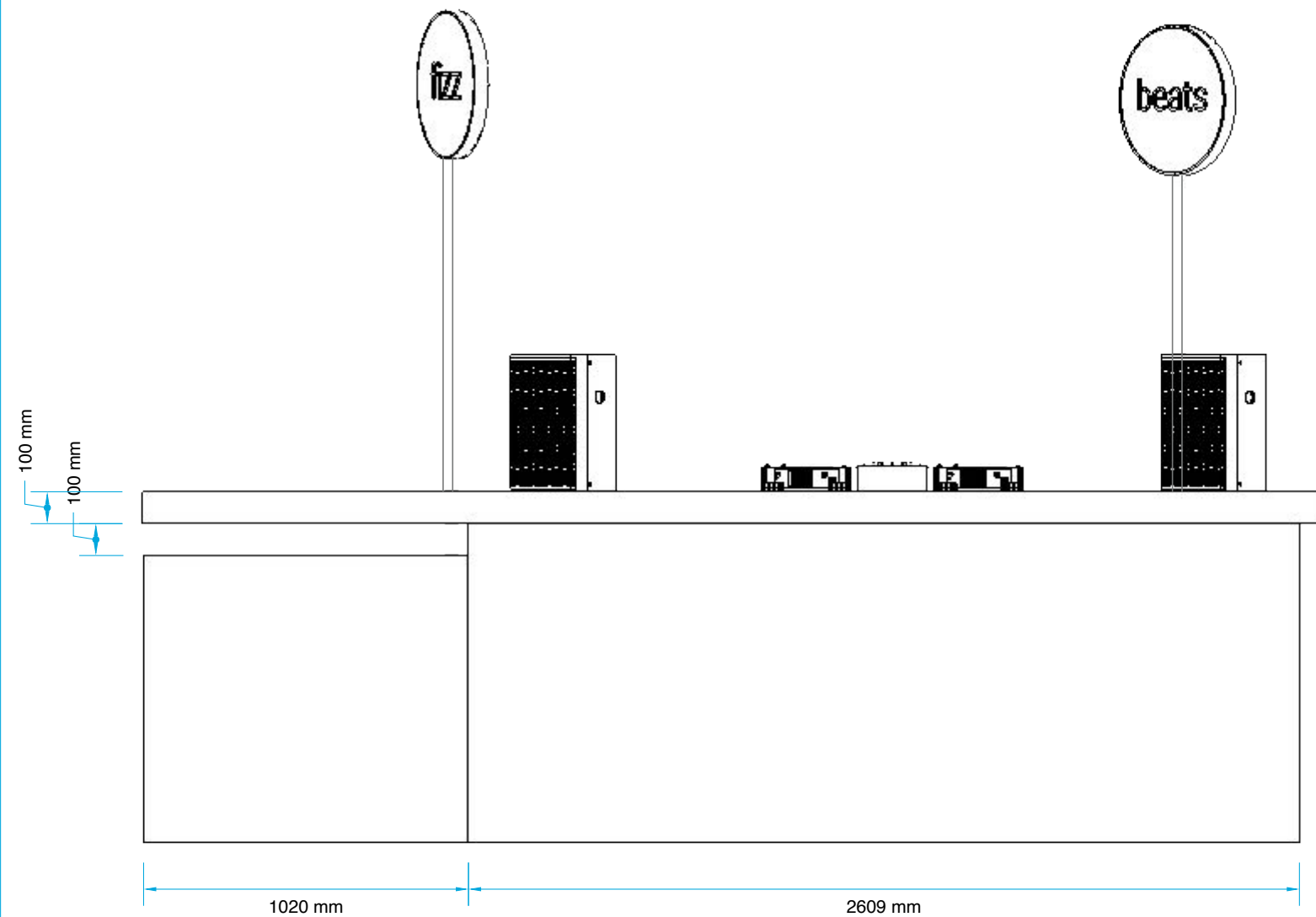

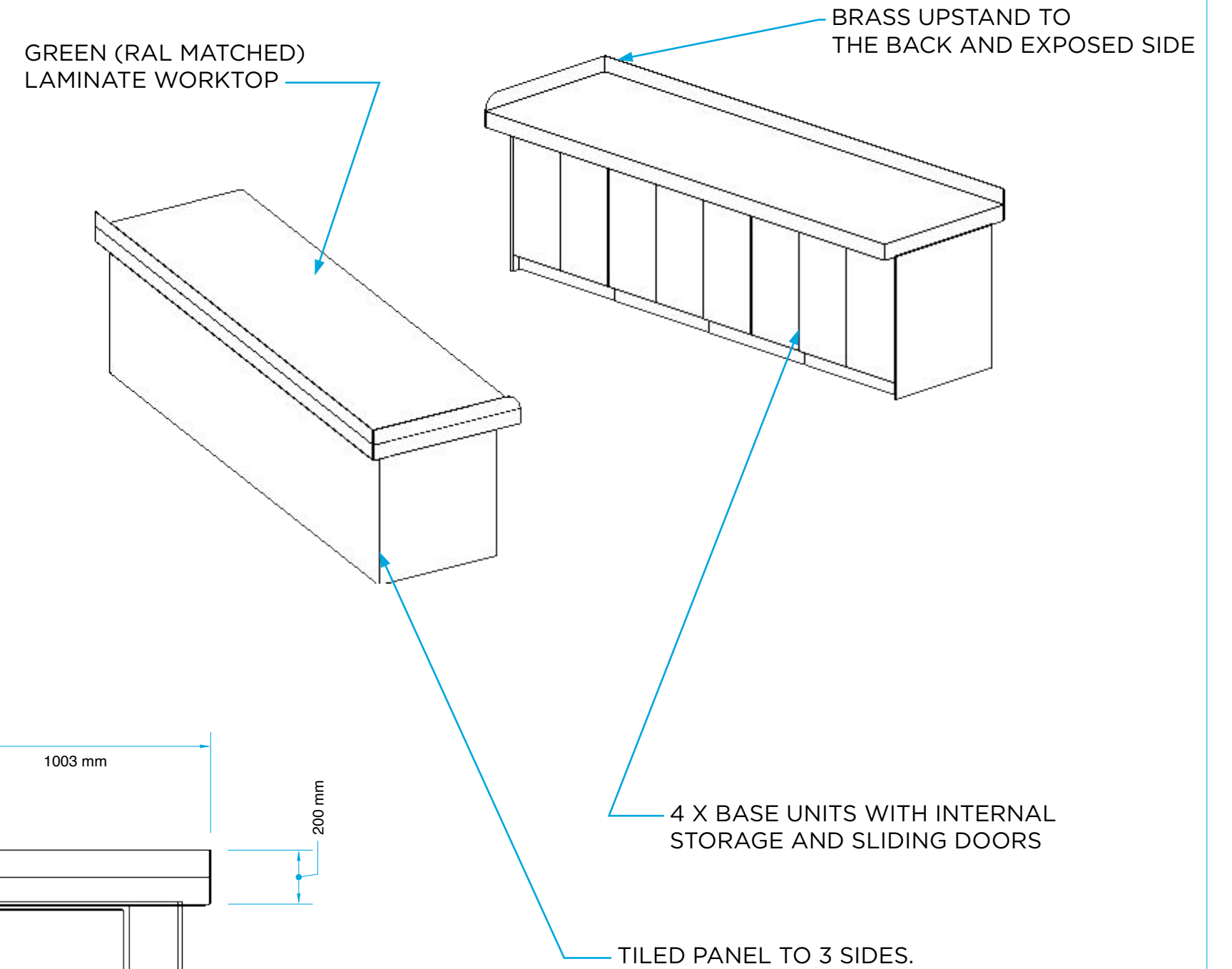
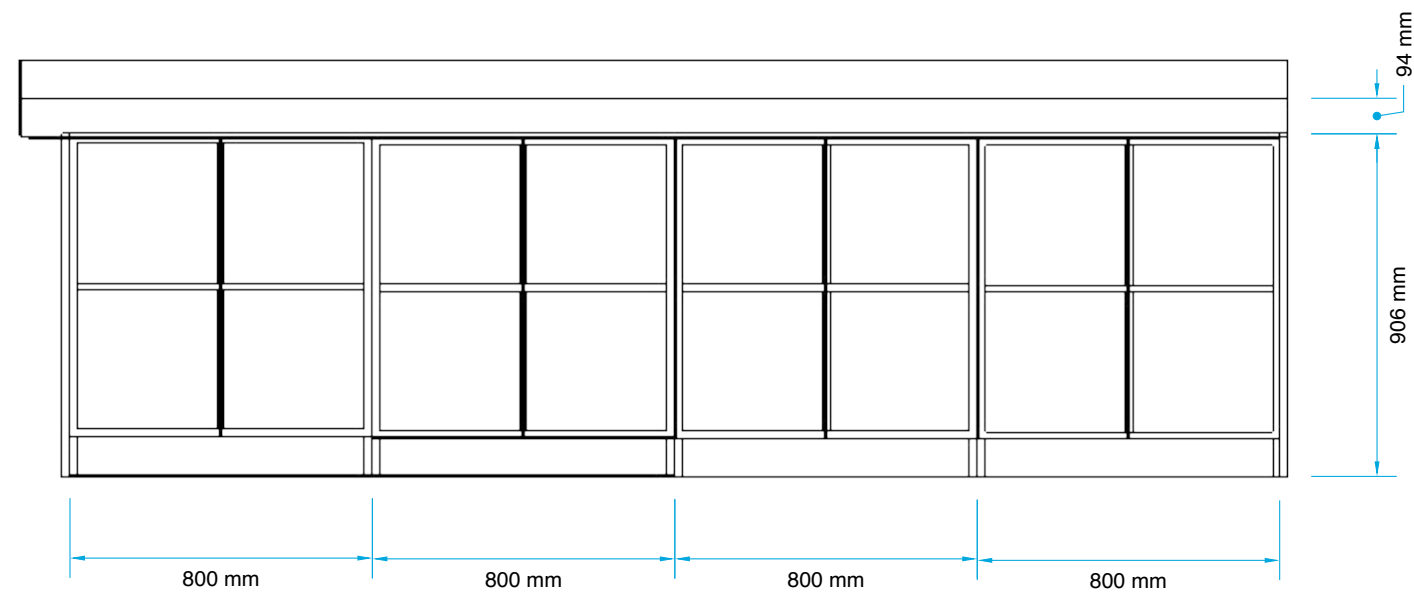
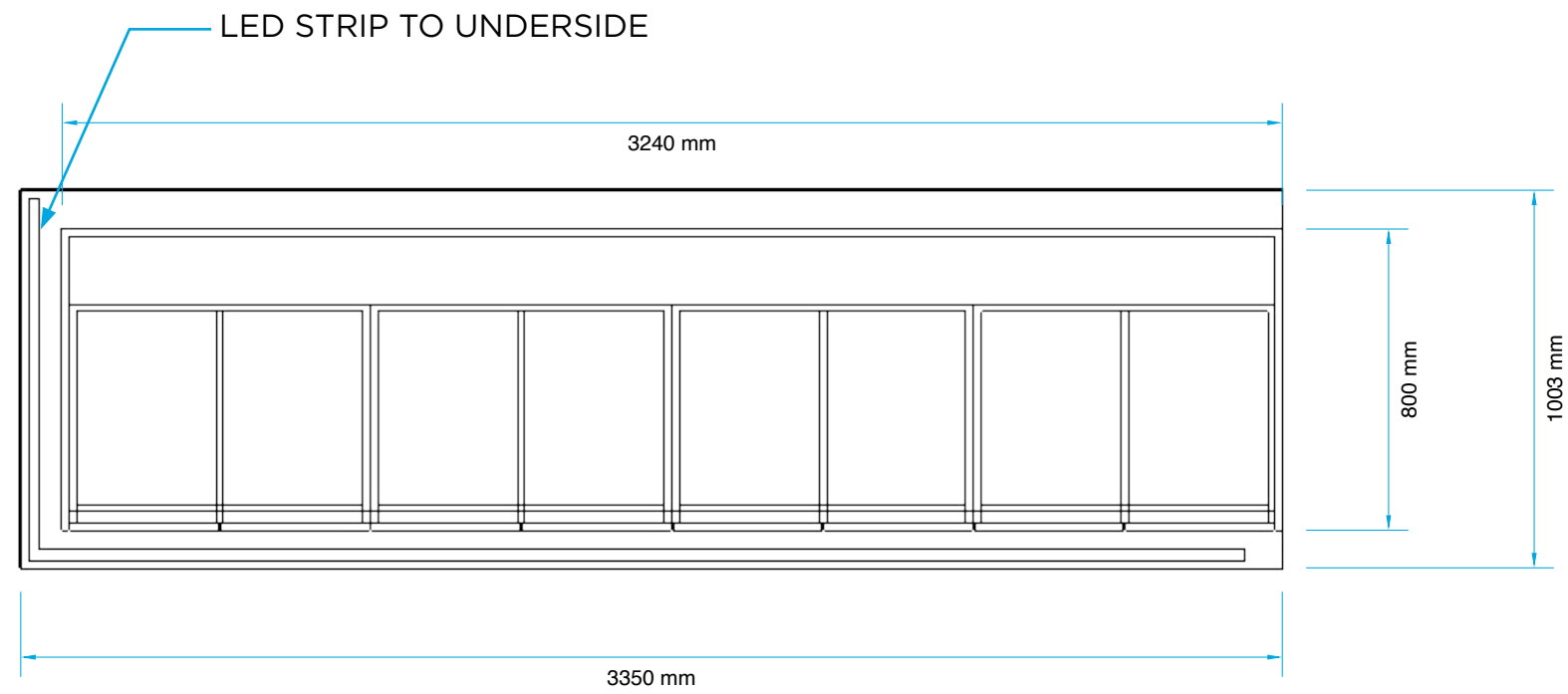

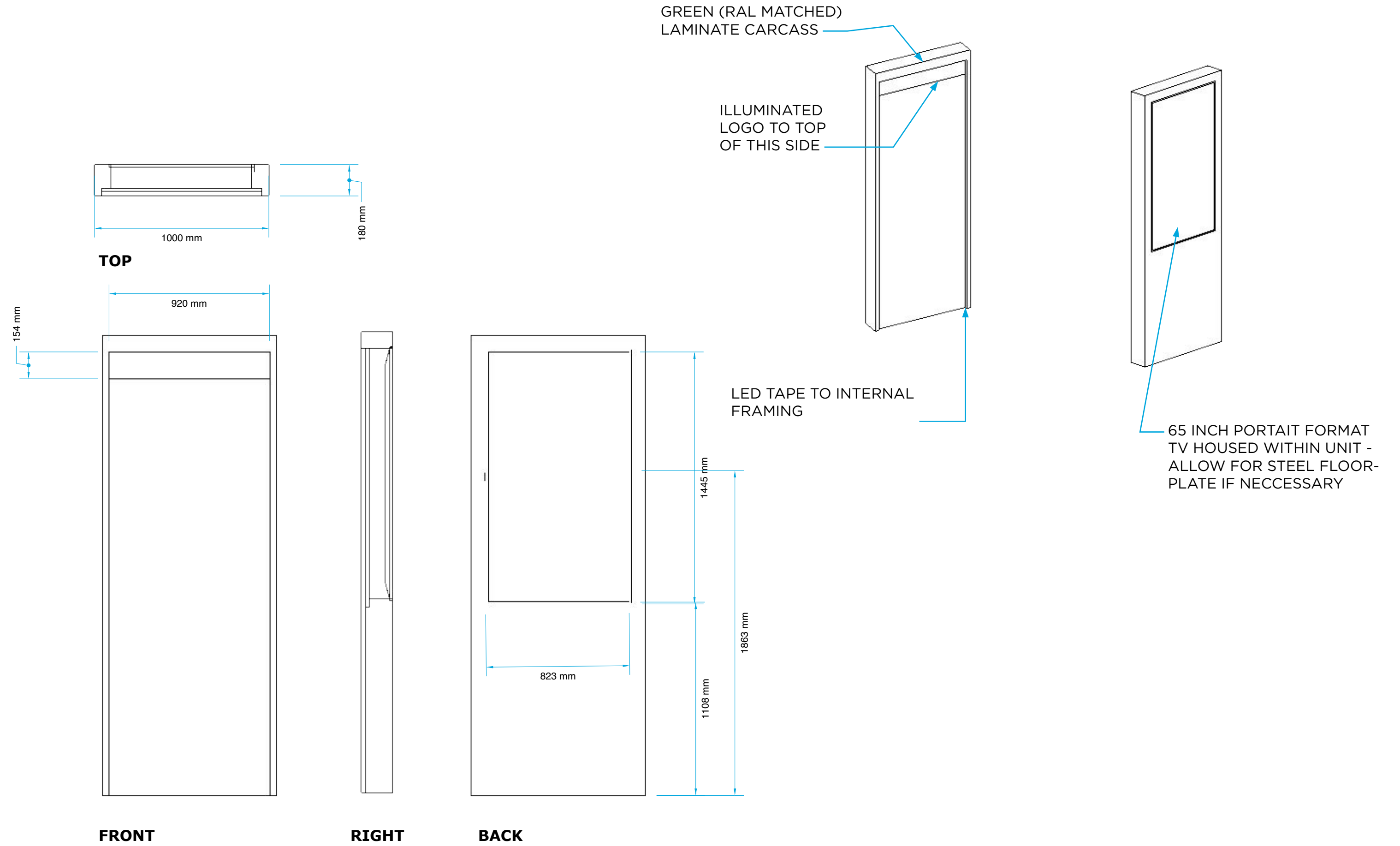

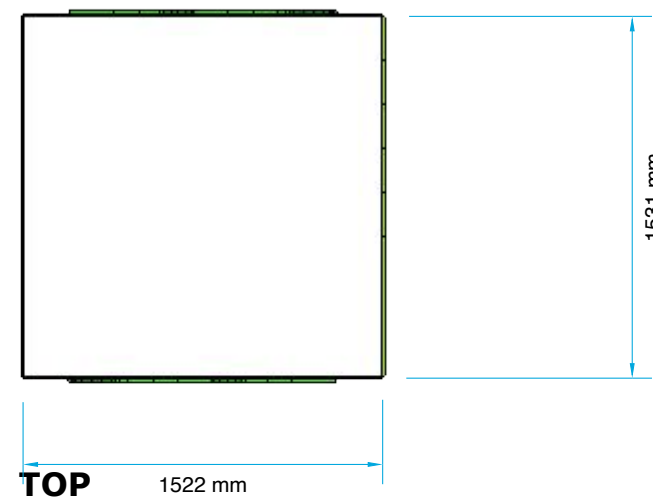

TOP TO INCLUDE 4 X EYELETS FOR HANGING FROM RIG

OPAL ACRYLIC BOX WITH GREEN ACRYLIC FRET-CUT BRANDING ON 4 SIDES

