

FLOOR PLAN - SCALE 1/30

- ABOVE THIS BALCONY WILL HAVE LAMPS EXPOSED
- PAINTING (WE WILL SEND READY)
- DISPLAY SHELVES
- STEP FOR GARDEN PRODUCTS
- BLUE PILLAR

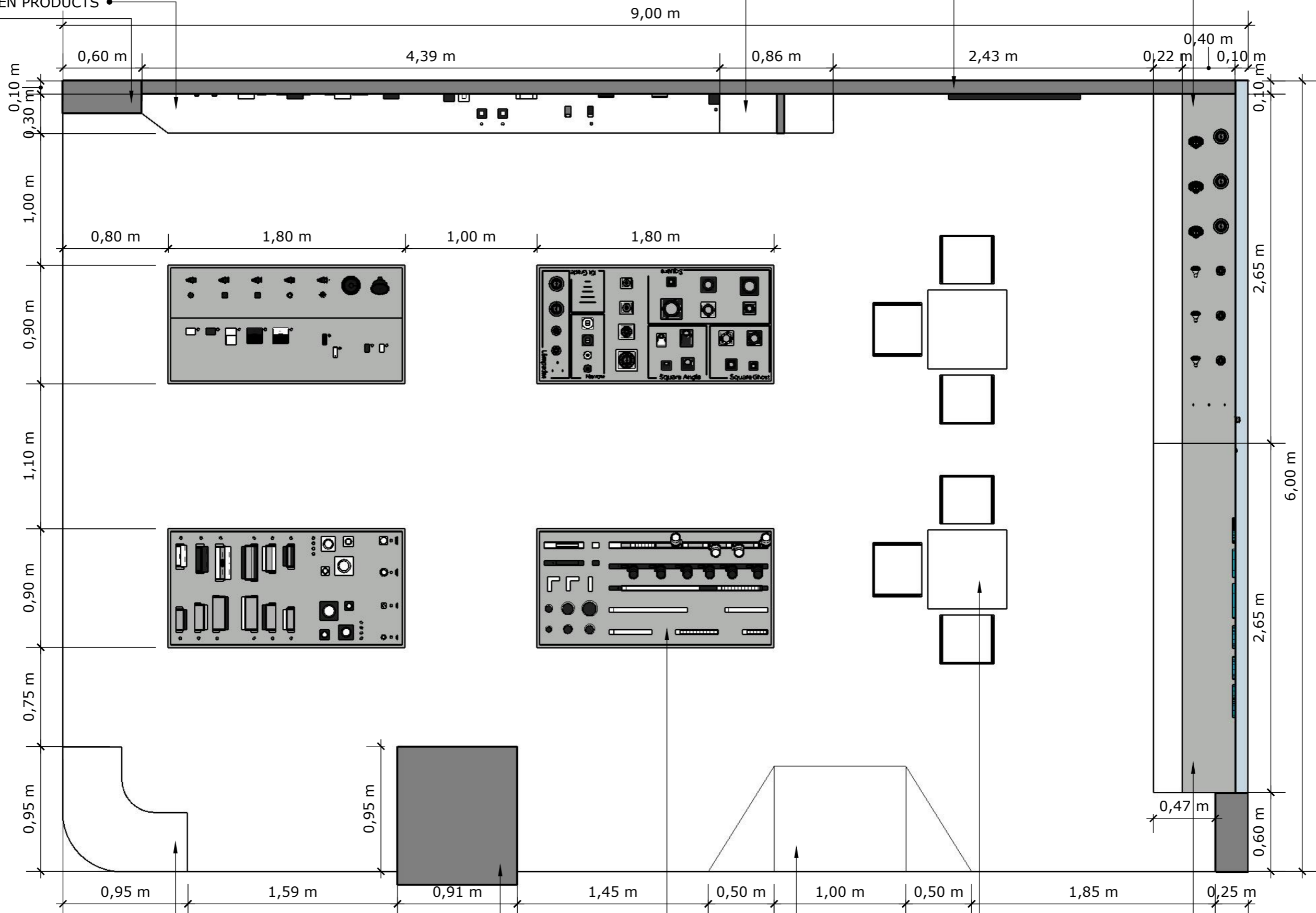

- SERVICE AND SUPPORT DESK
- EXISTING PILLAR
- 4 EXHIBITION TABLES
- ACCESS RAMP
- 2 BISTRO TABLES
- 2 SUPPORT AND DISPLAY BALCONIES

FRONT VIEW SIDE 1 - SCALE 1/30



FRONT VIEW SIDE 2 - SCALE 1/30

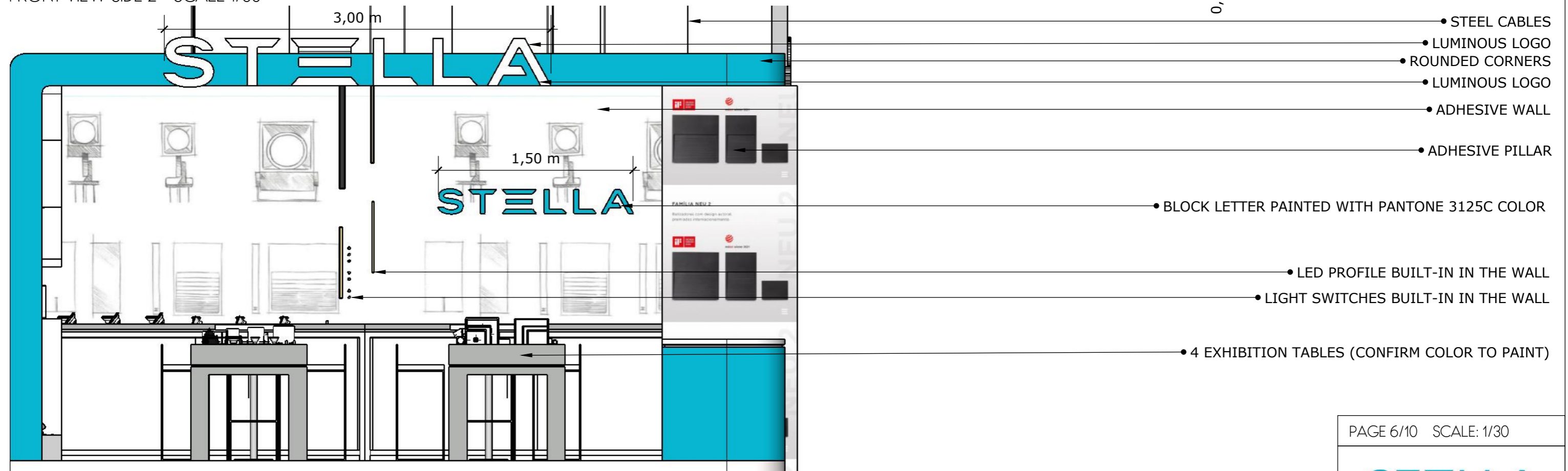

FRONT VIEW SERVICE AND SUPPORT DESK - WITHOUT SCALE

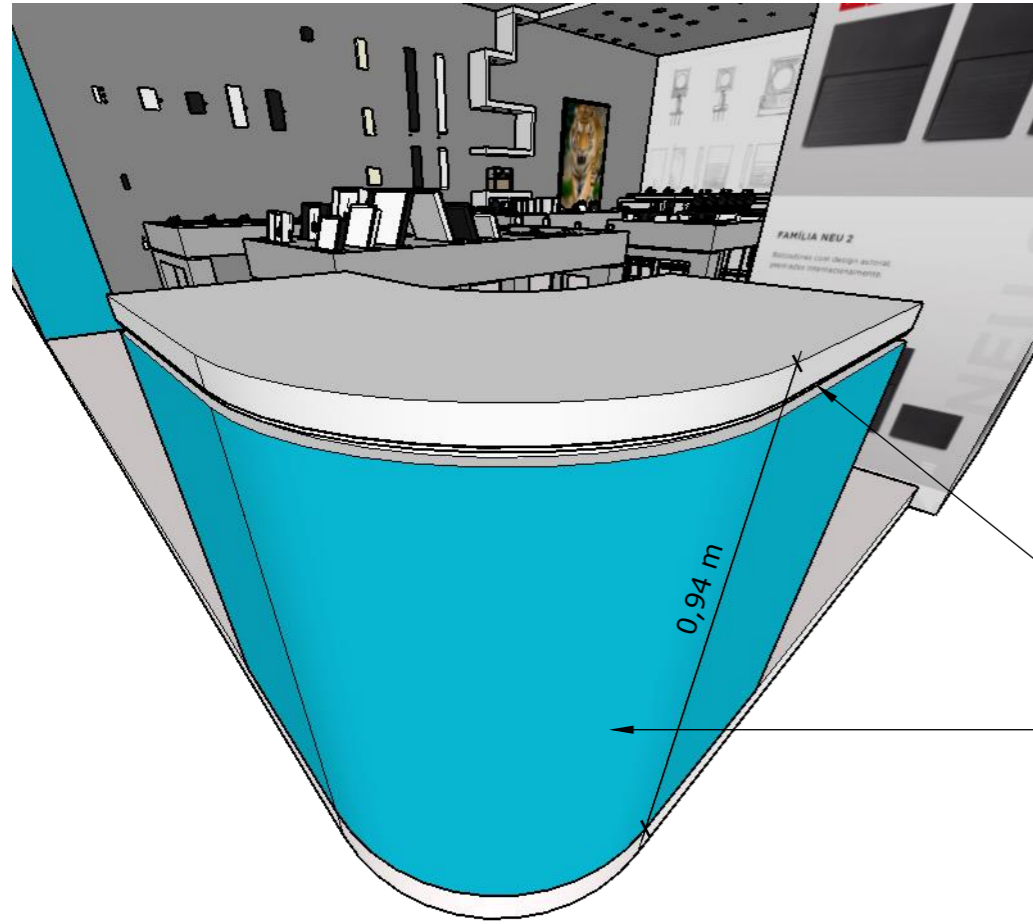

INTERNAL VIEW SERVICE AND SUPPORT DESK - WITHOUT SCALE

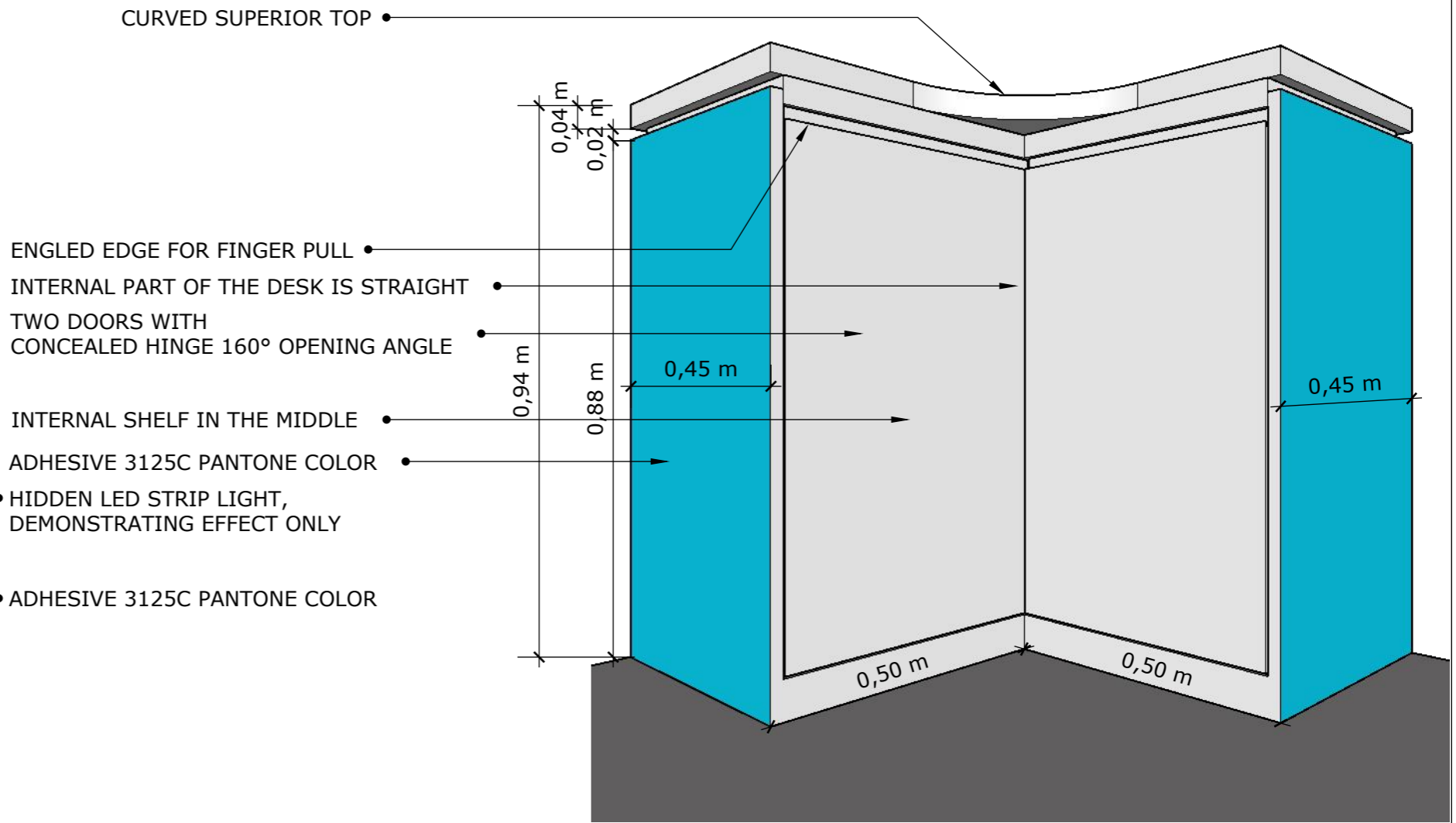

FLOOR PLAN SERVICE AND SUPPORT DESK - SCALE 1/10

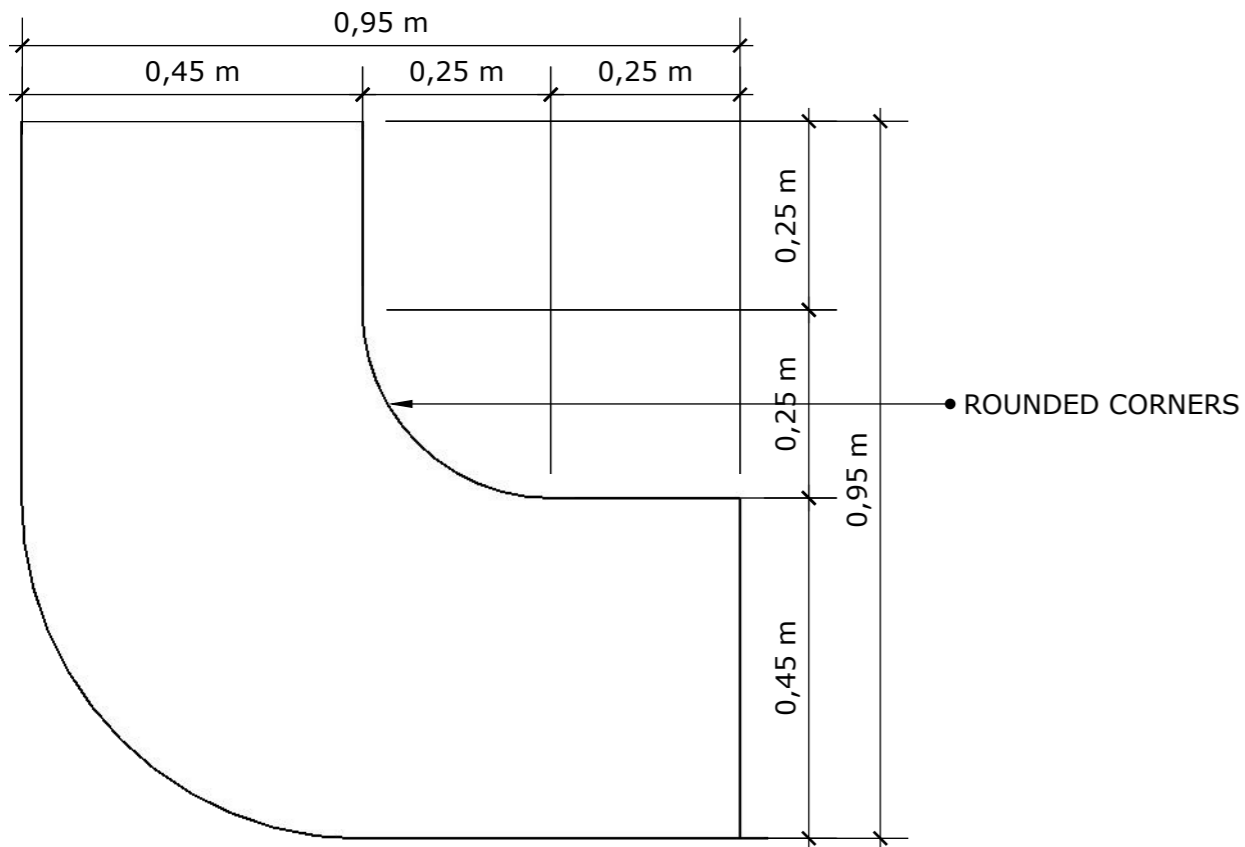

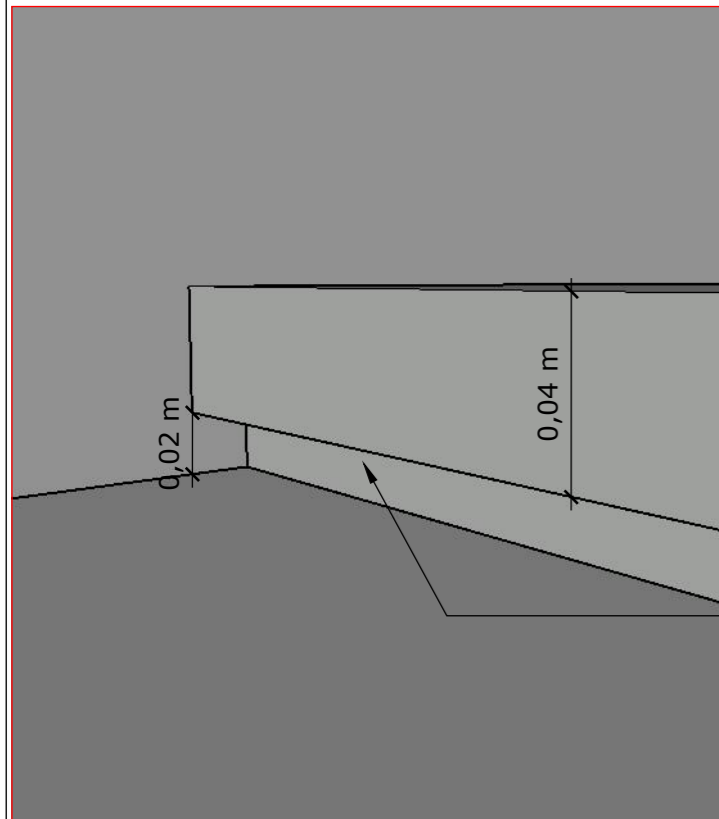

• HIDDEN LED STRIP LIGHT, DEMONSTRATING EFFECT ONLY

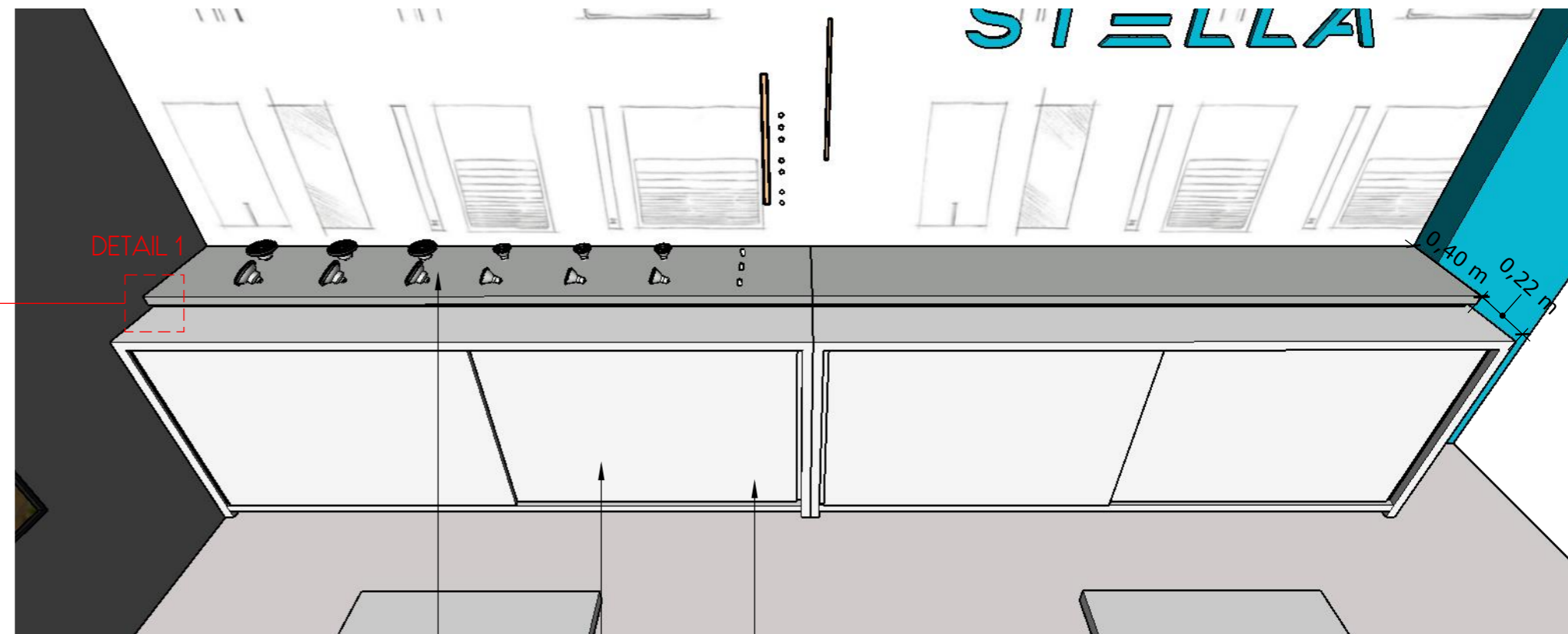

FRONT VIEW - SCALE 1/30

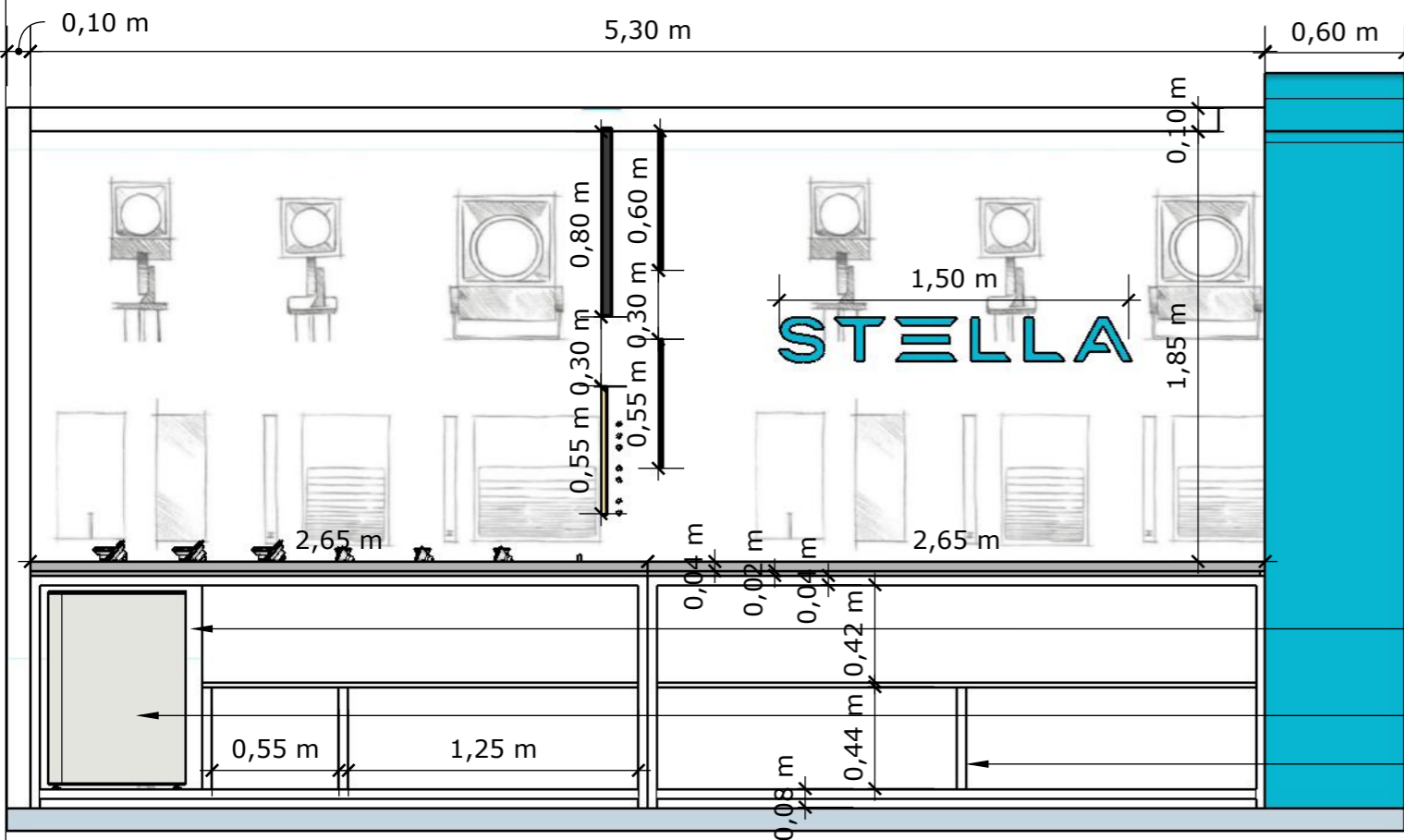

• TWO SUPPORT AND DISPLAY COUNTER
 • SLIDING DOORS
 • BUILT-IN LAMP SOCKET IN THE TOP

• DO NOT PUT BACKGROUND BEHIND THE FRIGOBAR
 • FRIDGE INSIDE THE COUNTER
 • INTERNAL REINFORCEMENTS

FRONT VIEW - SCALE 1/30

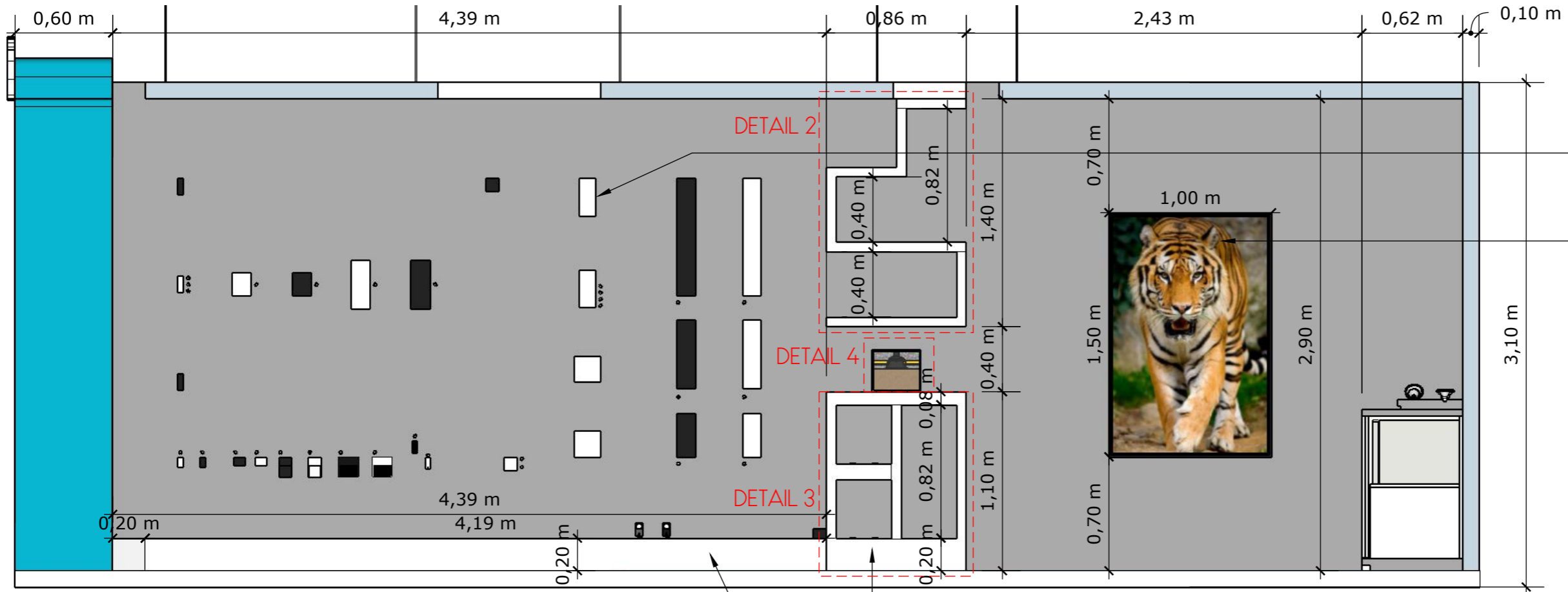

SPECIFIC DETAIL 2 - WITHOUT SCALE

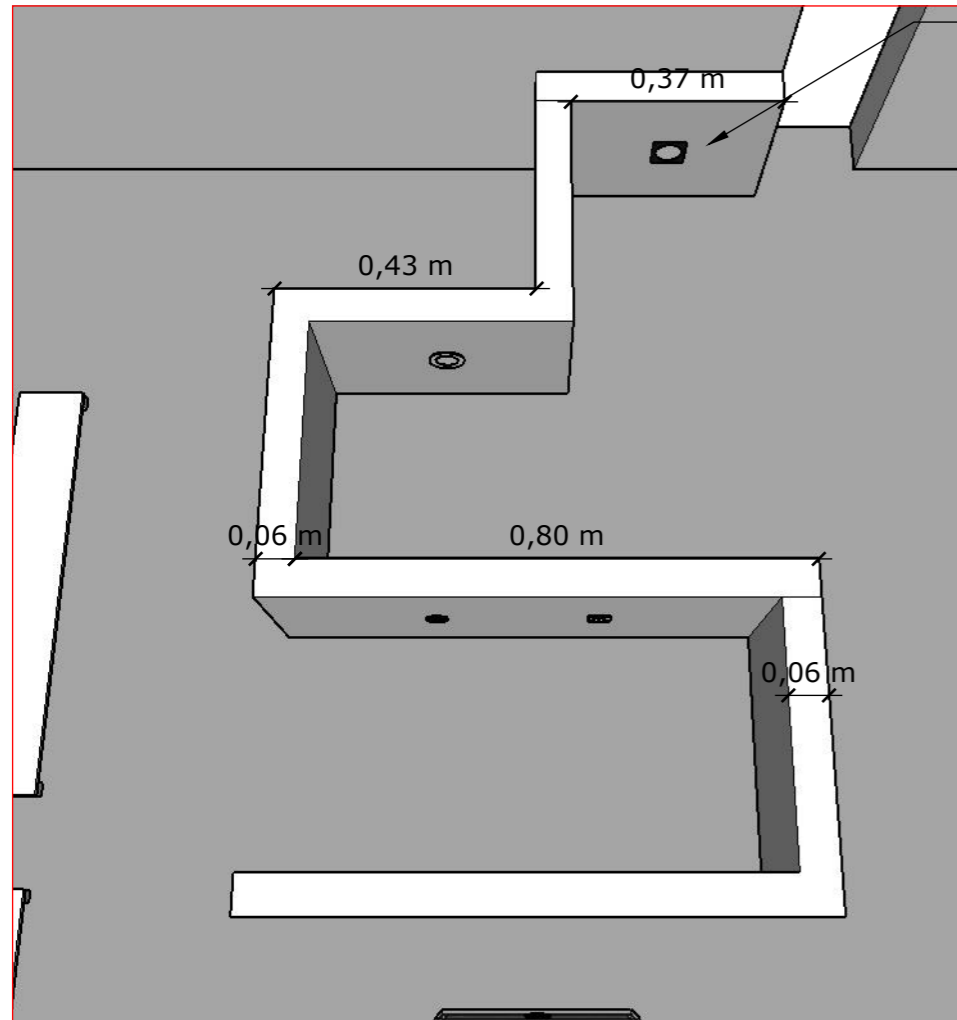

SPECIFIC DETAIL 3 - WITHOUT SCALE

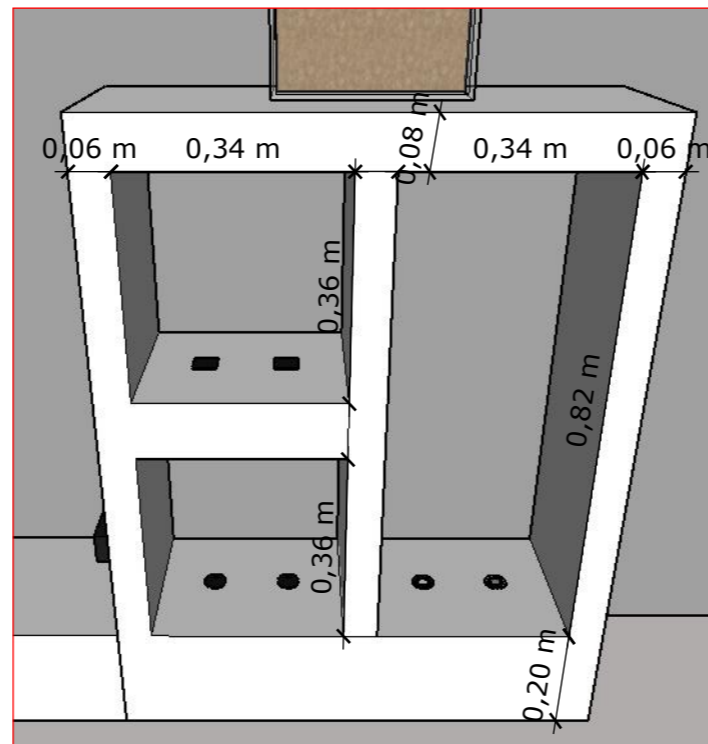

SPECIFIC DETAIL 4 - WITHOUT SCALE

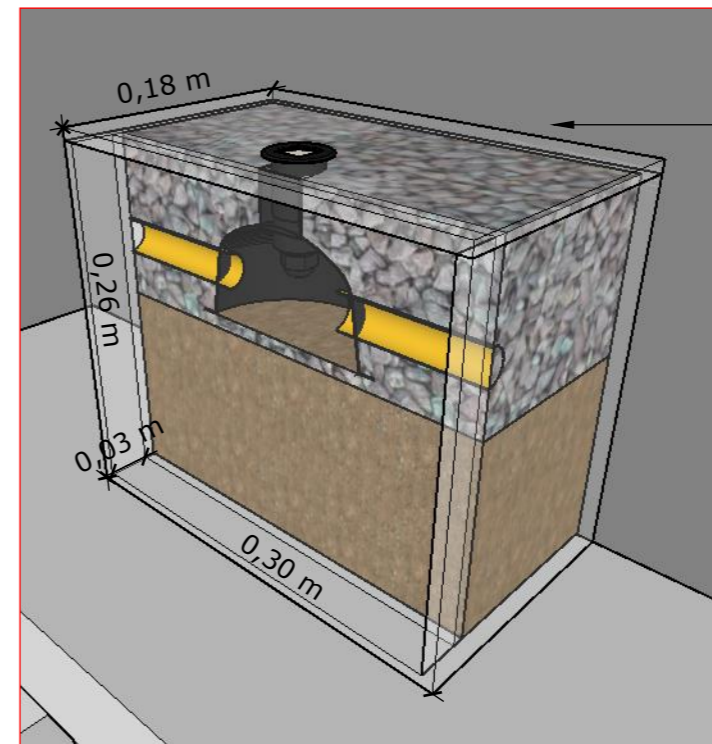

PERSPECTIVE VIEW FROM THE FOUR EXHIBITION TABLES - WITHOUT SCALE

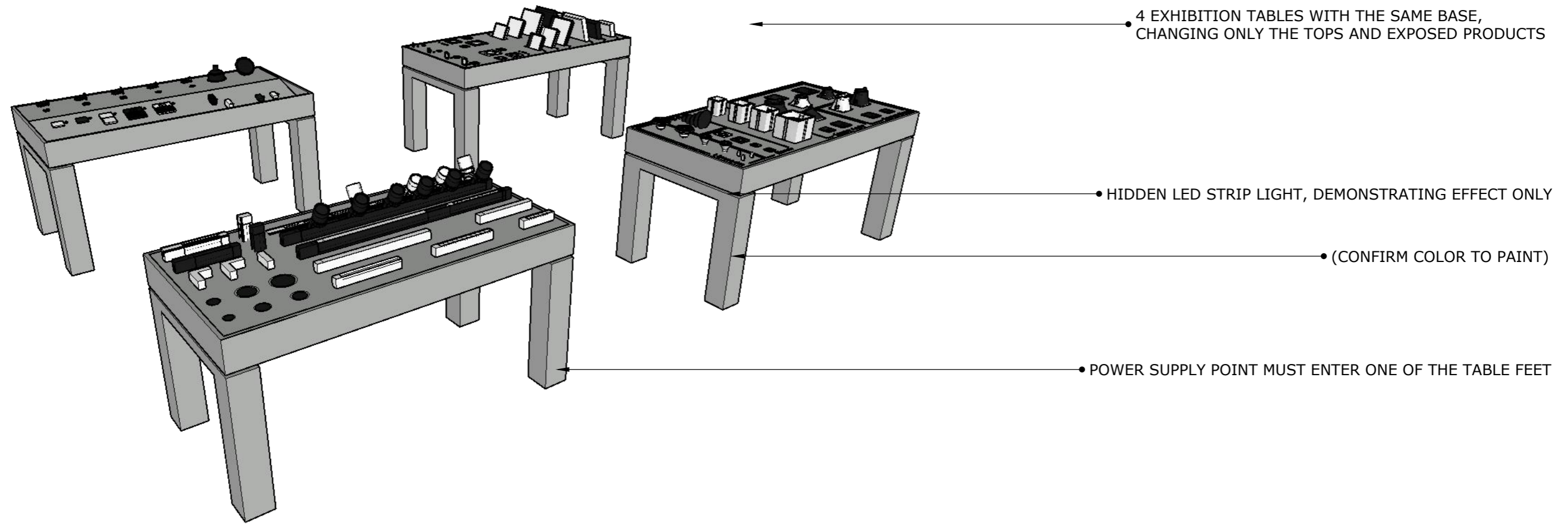

FRONT VIEW - SCALE 1/10

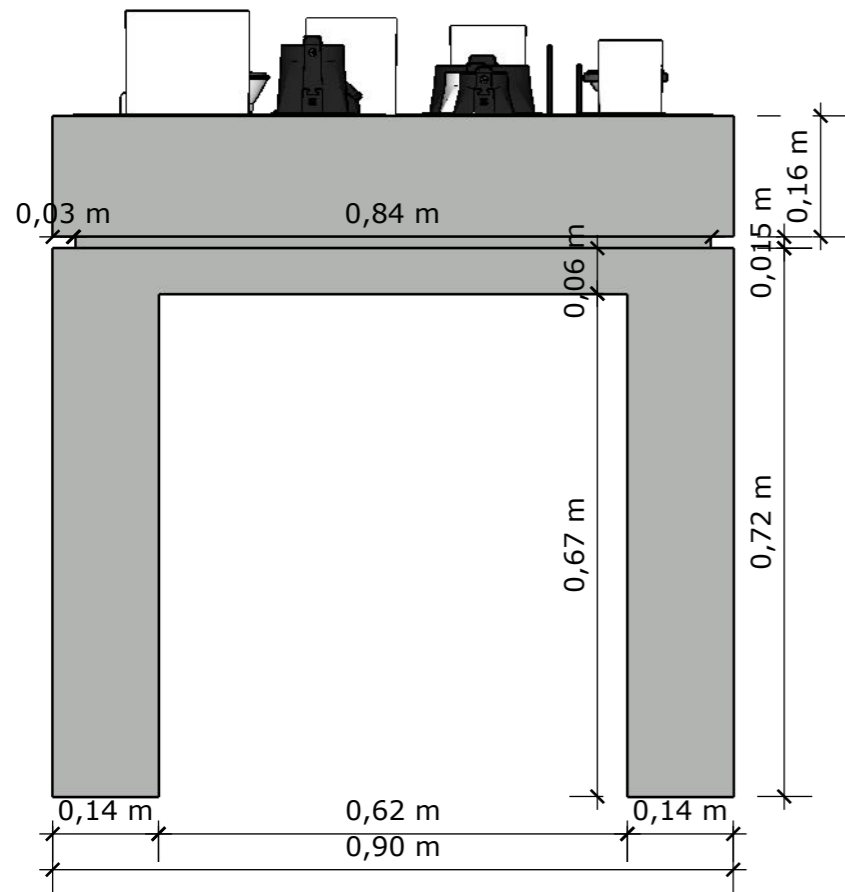

SIDE VIEW - SCALE 1/10

